



Caster Warehouse, Inc
a Division of World Casters & Equipment, Mfg



TABLE OF CONTENTS

Caster Series:

WC 3000 Series	1
WC 3300 Series	2
WC 3400 Series	3
WC 3600 Series	4, 5
WC 3800 Series	6, 7
WC 4000 Series	8, 9
WC 4900 Series	10
WC 5000 Series	11, 12, 13
WC S5000 Series	14, 15
WC 5200 Series	16, 17, 18
WC S5200 Series	19, 20
WC 5400 Series	21
WC 5700 Series	22, 23
WC 5500 Series	24, 25
WC 5600 Series	26, 27
WC 6400 Series	28, 29
WC 6600 Series	30, 31
WC S6600 Series	32, 33
WC 6800 Series	34, 35
WC 6900 Series	36
WC 7000 Series	37
WC 7600 Series	38, 39
WC 9000 Series	40, 41
WC 9100 Series	42, 43
WC 9200 Series	44, 45
WC 9400 Series	46, 47
WC 9500 Series	48, 49

Options & Components:

Pedal Wheel Brakes & Top Lock Brakes	50, 51
Position Locks	50
Quick Change Plates & Weld Plates	51
Expandable Adapters	51
Corner Bumpers	51

Options & Components (Continued):

Floor Locks	51
Axles & Spanner Bushings	52
Grip Ring Sockets	52
Bearings & Retainer Washers	53
Thread Guards & Bearing Covers	53

Wheels:

Centipede Wheel	54
Ductile Steel	55
Ductile V-Groove	56
Extreme-Duty Polyurethane on Steel	57
Hard & Soft Rubber	58
High-Temp Glass Filled Nylon	59
High-Temp Phenolic	59
Phenolic	60, 61
Pneumatic	62, 63
Polyolefin	64
Polyurethane on Aluminum	65
Polyurethane on Cast Iron	66
Polyurethane on Polyolefin	67, 68
Solid Polyurethane	69
Rubber on Aluminum	70
Balloon Cushion Rubber on Aluminum	70
Rubber on Cast Iron	71
Steel (Cast Iron)	72, 73
Thermo Plastic Rubber on Polyolefin	74, 75
V-Groove (Cast Iron)	76

Material Handling Equipment:

“U-boat” Utility Cart	77
Appliance Hand-Truck	78
Fold-Down Hand-Truck	79
Stacking Star Dolly	80

Custom Designed Wheels

Notes	82
Terms and Conditions	83



WC 3000 SERIES



- Capacity to 120 lbs.
- Double ball raceway.
- Variety of fastenings
- Integrated top-lock brakes provide a sure lock.
- L21 stem fastener for rolling ladders (old 3100 series).
- Applications: Mobile medical equipment, light weight institutional & food service equipment, office equipment, chairs, displays, stands, automobile creepers, mop buckets, rolling ladders, etc.

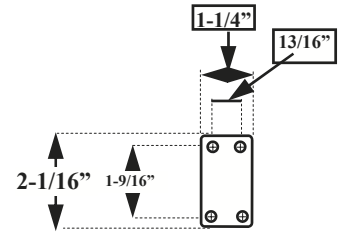

-01- TOP PLATE

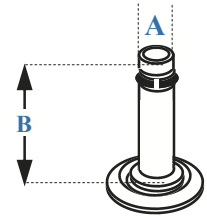

GRIP RING STEM

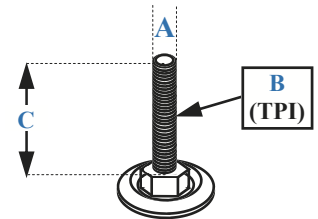

THREADED STEM

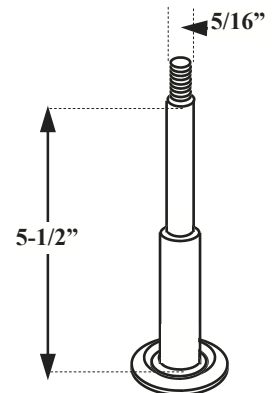

LADDER CASTER STEM

-L21-

WHEEL	SWIVEL #	WHEEL	WHEEL	WHEEL	WHEEL	REPLACE ** WITH FASTENER CODE
						SWIVEL #
2	7/8	SOFT RUBBER	NYLON	100	1-13/16	WC3020-**-SR
		HARD RUBBER	NYLON	100		WC3020-**-HR
		NYLON	PLAIN	100		WC3020-**-NY
		POLYOLEFIN	PLAIN	100		WC3020-**-LDP
		POLY-U ON POLY-O (GRAY/BEIGE)	PLAIN	100		WC3020-**-PPPG
THERMAL PLASTIC RUBBER	PLAIN	100	WC3020-**-TRP			
2-1/2	13/16	SOFT RUBBER	NYLON	105	2-1/16	WC3025-**-SR
		HARD RUBBER	NYLON	110		WC3025-**-HR
		POLYOLEFIN	PLAIN	110		WC3025-**-LDP
		POLY-U ON POLY-O (GRAY/BEIGE)	PLAIN	110		WC3025-**-PPPG
		THERMAL PLASTIC RUBBER	PLAIN	105		WC3025-**-TRP
3	13/16	SOFT RUBBER	NYLON	110	2-3/8	WC3030-**-SR
		HARD RUBBER	NYLON	120		WC3030-**-HR
		POLYOLEFIN	PLAIN	120		WC3030-**-LDP
		POLY-U ON POLY-O (GRAY/BEIGE)	PLAIN	120		WC3030-**-PPPG
		THERMAL PLASTIC RUBBER	PLAIN	110		WC3030-**-TRP

FASTENER TYPE	CODE	SIZE
TOP PLATE	01	OVERALL: 1-1/4 x 2-1/16 HOLE SPACING: 13/16 x 1-9/16 ATTACHING BOLT SIZE: 3/16
GRIP RING STEM	11	A x B 7/16 x 1-3/16
THREADED STEM	20 21 23 24 25	A-B x C 1/2-13 x 1/2 5/16-18 x 1 3/8-16 x 1 3/8-16 x 1-1/4 3/8-16 x 1-1/2
LADDER CASTER STEM	L21	5/16 x 5-1/2

FASTENER	OVERALL HEIGHT VARIES PER FASTENER		
	FOR 2"	FOR 2-1/2"	FOR 3"
01	2-5/8	3-1/8	3-5/8
11	2-5/8	3-1/8	3-5/8
20 THRU 25	2-3/4	3-3/16	3-11/16
L21	2-1/2	N/A	3-1/2

OPTIONS FOR WC 3000 SERIES (Add option abbreviation to end of the caster part #)

INTEGRATED TLB
Available on 2"



TLB

OLD STYLE TLB
Available on 3"



TLB

SPECIAL FINISHES (FACTORY ORDER)

POLISHED	PGF
GOLD FINISH	
BLACK OXIDE	BO
NICKLE	N
CHROME	CR

WC 3300 SERIES



- Capacity up to 260 lbs.
- Case hardened double ball raceways provide extra capacity & durability
- Sealed raceway is standard with top plate fastener type.
- High capacities with low overall heights.
- Bright zinc finish standard.
- Applications: Business machines, copiers, printers, diagnostic equipment, computer main frame tower carts and stands, vending machines, magazine racks, store check-out racks, displays, video games, pianos, etc.

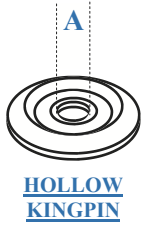

DUAL WHEEL STYLE

							REPLACE ** WITH FASTENER CODE
2	2 x 13/16	HARD RUBBER THERMAL PLASTIC RUBBER	PLAIN	260 220	1-7/8	2-13/16	SWIVEL # WC3322-**-HR WC3322-**-TRP

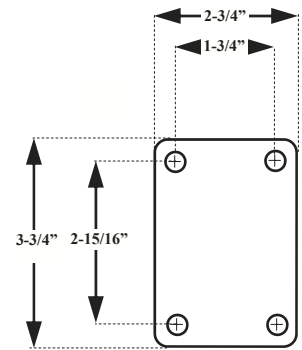

-01-
TOP PLATE

							REPLACE ** WITH FASTENER CODE
2	1-13/16	POLYOLEFIN	PLAIN	260	1-7/8	2-13/16	SWIVEL # WC3320-**-HDP

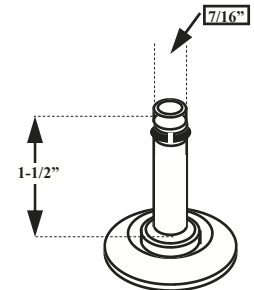

-11-
GRIP RING STEM

FASTENERS FOR WC 3300 SERIES		
HOLLOW KINGPIN	038 012	FOR (A) 3/8 ATTACHING BOLT FOR (A) 1/2 ATTACHING BOLT
TOP PLATE	01	OVERALL: 2-3/4 x 3-3/4 HOLE SPACING: 1-3/4 x 2-15/16 ATTACHING BOLT SIZE: 5/16
GRIP RING STEM	11	7/16 x 1-1/2
THREADED STEM	21	1/2-13 x 1-1/2

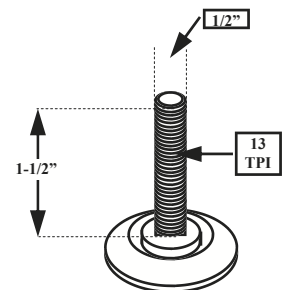

-21-
THREADED STEM

OPTIONS FOR WC 3300 SERIES (Add option abbreviation to end of the caster part #)

OPTIONS: (WC 3320 & WC 3322)
THUMB SCREW BRAKE



TSB

SPECIAL FINISHES (FACTORY ORDER)

POLISHED GOLD FINISH	PGF
BLACK OXIDE	BO
NICKLE	N
CHROME	CR

WC 3400 SERIES



- Capacity to 220 lbs.
- Case hardened double ball raceways provide extra capacity & durability
- Unique, 1-3/4" wide x 3" long (-01-) Top plate fastener, was developed to be able to be attached to a 2" square tube without protruding past the ends of the tube.
- Applications: Food service & institutional equipment, light-duty service carts (for hotels, resorts, hospitals, and restaurants), & light duty stock carts, displays, etc.

WHEEL	Yoke	WHEEL	Raceway	Yoke	Yoke	Yoke	REPLACE ** WITH FASTENER CODE	
							SWIVEL #	RIGID #
3	1	SOFT RUBBER	NYLON	110	2-13/16	3-7/8	WC3430-**-SR	WC3430R-**-SR
		HARD RUBBER	NYLON	130			WC3430-**-HR	WC3430R-**-HR
		POLYOLEFIN	PLAIN	175			WC3430-**-LDP	WC3430R-**-LDP
		POLY-U ON POLY-O (GRAY/BEIGE)	PLAIN	175			WC3430-**-PPPG	WC3430R-**-PPPG
		THERMAL PLASTIC RUBBER	PLAIN	175			WC3430-**-TRP	WC3430R-**-TRP
		YOKE AXLE & NUT	-	220			WC3430-**-YAN	WC3430R-**-YAN
4	1	SOFT RUBBER	NYLON	130	3-1/4	4-7/8	WC3440-**-SR	WC3440R-**-SR
		HARD RUBBER	NYLON	175			WC3440-**-HR	WC3440R-**-HR
		POLYOLEFIN	OILITE	220			WC3440-**-HDPO	WC3440R-**-HDPO
		POLY-U ON POLY-O (GRAY/BEIGE)	PLAIN	220			WC3440-**-PPPG	WC3440R-**-PPPG
		THERMAL PLASTIC RUBBER	PLAIN	190			WC3440-**-TRP	WC3440R-**-TRP
		YOKE AXLE & NUT	-	220			WC3440-**-YAN	WC3440R-**-YAN
5	1	SOFT RUBBER	NYLON	150	3-13/16	5-7/8	WC3450-**-SR	WC3450R-**-SR
		HARD RUBBER	NYLON	220			WC3450-**-HR	WC3450R-**-HR
		POLYOLEFIN	OILITE	220			WC3450-**-HDPO	WC3450R-**-HDPO
		POLY-U ON POLY-O (GRAY/BEIGE)	PLAIN	220			WC3450-**-PPPG	WC3450R-**-PPPG
		THERMAL PLASTIC RUBBER	PLAIN	200			WC3450-**-TRP	WC3450R-**-TRP
		YOKE AXLE & NUT	-	220			WC3450-**-YAN	WC3450R-**-YAN

FASTENERS FOR WC 3400 SERIES		
TYPE	CODE	SIZE
TOP PLATE	01	OVERALL: 1-3/4 x 3 HOLE SPACING: 1 x 2-3/16 SLOTTED TO 2-5/16 ATTACHING BOLT SIZE: 5/16
TOP PLATE	04	OVERALL: 2-1/2 x 3-3/4 HOLE SPACING: 1-3/4 x 2-7/8 SLOTTED TO 3 ATTACHING BOLT SIZE: 5/16

OPTIONS FOR WC 3400 SERIES (Add option abbreviation to end of the caster part #)

TOP LOCK BRAKE



TLB

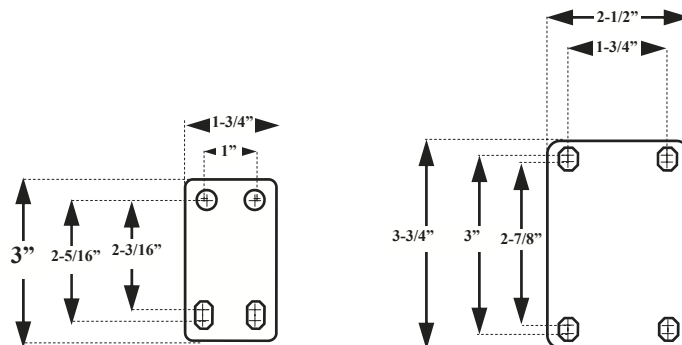

01 TOP PLATE

04 PLATE

SPECIAL FINISHES (FACTORY ORDER)	
POLISHED GOLD FINISH	PGF
BLACK OXIDE	BO
NICKLE	N
CHROME	CR

WC 3600 SERIES



- Capacity to 230 lbs.
- Available with over half a dozen fastener options.
- Double ball raceway.
- Applications: Bakery racks, laundry carts, light duty stock carts, food service equipment, service carts (for hotels, resorts, hospitals, and restaurants), garment racks, Z trucks, etc.



WHEEL	FASTENER	WHEEL	WHEEL	WHEEL	WHEEL	WHEEL	REPLACE ** WITH FASTENER CODE	
							SWIVEL #	RIGID #
3	1	SOFT RUBBER	NYLON	110	2-13/16	3-3/4	WC3630-**-SR	WC3630R-**-SR
		HARD RUBBER	NYLON	130			WC3630-**-HR	WC3630R-**-HR
		POLYOLEFIN	PLAIN	175			WC3630-**-LDP	WC3630R-**-LDP
		POLY-U ON POLY-O (GRAY/BEIGE)	PLAIN	175			WC3630-**-PPPG	WC3630R-**-PPPG
		THERMAL PLASTIC RUBBER	PLAIN	175			WC3630-**-TRP	WC3630R-**-TRP
YOKE AXLE & NUT	-	230	WC3630-**-YAN	WC3630R-**-YAN				
4	1	SOFT RUBBER	NYLON	130	3-1/4	4-3/4	WC3640-**-SR	WC3640R-**-SR
		HARD RUBBER	NYLON	175			WC3640-**-HR	WC3640R-**-HR
		POLYOLEFIN	OILITE	220			WC3640-**-HDPO	WC3640R-**-HDPO
		POLY-U ON POLY-O (GRAY/BEIGE)	PLAIN	220			WC3640-**-PPPG	WC3640R-**-PPPG
		THERMAL PLASTIC RUBBER	PLAIN	190			WC3640-**-TRP	WC3640R-**-TRP
YOKE AXLE & NUT	-	230	WC3640-**-YAN	WC3640R-**-YAN				
5	1	SOFT RUBBER	NYLON	150	3-1/2	5-3/4	WC3650-**-SR	WC3650R-**-SR
		HARD RUBBER	NYLON	220			WC3650-**-HR	WC3650R-**-HR
		POLYOLEFIN	OILITE	230			WC3650-**-HDPO	WC3650R-**-HDPO
		POLY-U ON POLY-O (GRAY/BEIGE)	PLAIN	220			WC3650-**-PPPG	WC3650R-**-PPPG
		THERMAL PLASTIC RUBBER	PLAIN	200			WC3650-**-TRP	WC3650R-**-TRP
YOKE AXLE & NUT	-	230	WC3650-**-YAN	WC3650R-**-YAN				

FASTENERS FOR WC 3600 SERIES		
FASTENER TYPE	CODE	SIZE
TOP PLATE	01	OVERALL: 2-3/4 x 3-3/4 HOLE SPACING: 1-3/4 x 2-7/8 SLOTTED TO 3 ATTACHING BOLT SIZE: 5/16
GRIP RING STEM	11 12 14 17	A x B 7/16 x 1-1/2 .845 x 2-3/16 1.48 x 3 WITH TWO GRIP RINGS (TOP & BOTTOM) 7/16 x 2
THREADED STEM (WITH HEX RACEWAY)	21 22 23 24	A-B x C 1/2-13 x 1-1/2 7/16-14 x 2-1/4 1/2-13 x 1 1/2-13 x 2-1/4
PIPE THREAD (NPT)	26N 34PT	1/2-13 x 2-13/16 THREADED FOR 3/4" PIPE COUPLING x 3/4" LONG
EXPANDABLE ADAPTER STEMS	25 26 27 28 29	FOR 1-3/8 I.D. 1-1/2 O.D. TUBING FOR 1-1/2" I.D. 1-5/8 O.D. TUBING FOR 7/8" I.D. 1" O.D. TUBING FOR 1" I.D. 1-1/8" O.D. TUBING FOR 1-1/8" I.D. 1-1/4 O.D. TUBING
ROUND PLAIN STEM	31	7/8 x 1-7/16 WITH 5/16 CROSS DRILLED HOLE 29/32 UP
OCTAGON	42	7/8 x 2 WITH 5/16 CROSS DRILLED HOLE 1" UP
ROUND STEM FOR ADJUSTABLE LEG	61 62	1-1/4" DIAMETER x 4" LONG ROUND STEM WITH A 3/4" THREADED HOLE 3-3/4" DEEP. 1-1/4" DIAMETER x 2" LONG ROUND STEM WITH A 3/4" THREADED HOLE 1-1/4" DEEP.



WC 3600 SERIES

FASTENER DIAGRAMS

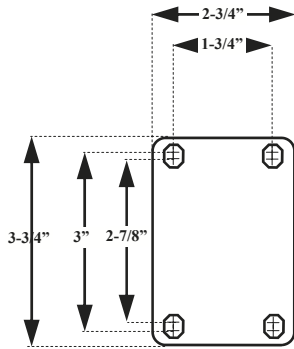

-01- TOP PLATE

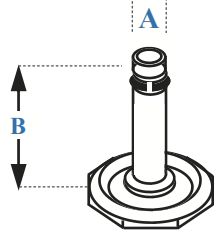

-11-, -12-, -17- GRIP RING STEM

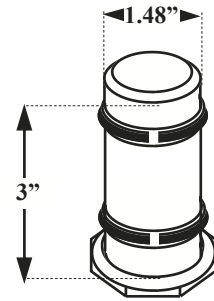

-14- GRIP RING STEM

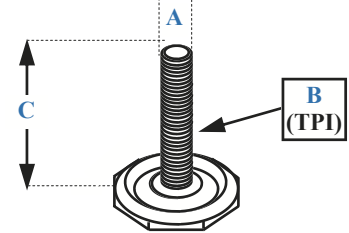

THREADED STEM

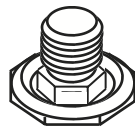

34PT PIPE THREAD STEM

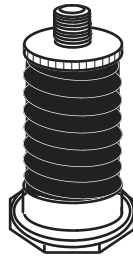

-26-

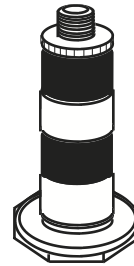

-29-

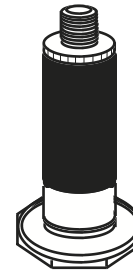

-25-, -27-, -28-

EXPANDABLE ADAPTER STEMS

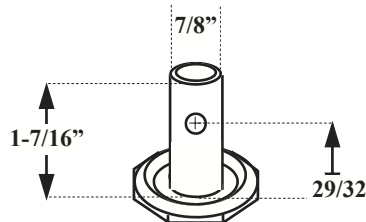

-31- ROUND STEM

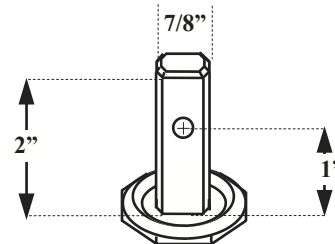

-42- OCTAGON STEM

OPTIONS FOR WC 3600 SERIES

(Add option abbreviation to end of the caster part #)

TOP LOCK BRAKE



TLB

RIVETED AXLE
(FACTORY ORDER)



RA

SPECIAL FINISHES
(FACTORY ORDER)

POLISHED	PGF
GOLD FINISH	
BLACK OXIDE	BO
NICKLE	N
CHROME	CR

WC 3800 SERIES



- Economy Series. Designed as a cost effective alternative to the 5000 & 5200 series.
- Capacity up to 250 lbs.
- Case hardened double ball raceways.
- Large variety of fasteners for various applications.
- Applications: Light-duty material handling equipment, food service carts & equipment, bakery racks & equipment, institutional carts & equipment, miscellaneous dollies, mobile cases, displays, mobile wire racking, stock carts, textile applications, warehouse & manufacturing applications, etc.



WHEEL	WHEEL	WHEEL	WHEEL	WHEEL	WHEEL	WHEEL	REPLACE ** WITH FASTENER CODE	
							SWIVEL #	RIGID #
2	1	SOFT RUBBER HARD RUBBER POLYOLEFIN STEEL THERMAL PLASTIC RUBBER YOKE AXLE & NUT	NYLON NYLON PLAIN PLAIN PLAIN -	110 160 160 160 120 160	2	2-7/8	WC3820-**-SR WC3820-**-HR WC3820-**-HDP WC3820-**-STL WC3820-**-TRP WC3820-**-YAN	WC3820R-**-SR WC3820R-**-HR WC3820R-**-HDP WC3820R-**-STL WC3820R-**-TRP WC3820R-**-YAN
2-1/2	1-1/8	SOFT RUBBER HARD RUBBER HEAVY DUTY POLYOLEFIN POLY-U ON POLY-O THERMAL PLASTIC RUBBER STEEL YOKE AXLE & NUT	NYLON NYLON PLAIN OILLESS OILLESS PLAIN -	120 160 200 160 150 200 200	2-3/8	3-3/8	WC3825-**-SR WC3825-**-HR WC3825-**-HDP WC3825-**-PPOR WC3825-**-TRO WC3825-**-STL WC3825-**-YAN	WC3825R-**-SR WC3825R-**-HR WC3825R-**-HDP WC3825R-**-PPOR WC3825R-**-TRO WC3825R-**-STL WC3825R-**-YAN
3	1-1/4	SOFT RUBBER HARD RUBBER POLYOLEFIN POLY-U ON POLY-O (GRAY/BEIGE) THERMAL PLASTIC RUBBER PHENOLIC YOKE AXLE & NUT	NYLON NYLON PLAIN OILLESS OILLESS DELTRIN -	150 220 250 250 210 250 250	2-3/4	3-3/4	WC3830-**-SR WC3830-**-HR WC3830-**-LDP WC3830-**-PPOG WC3830-**-TRO WC3830-**-PHN WC3830-**-YAN	WC3830R-**-SR WC3830R-**-HR WC3830R-**-LDP WC3830R-**-PPOG WC3830R-**-TRO WC3830R-**-PHN WC3830R-**-YAN
4	1-1/4	SOFT RUBBER SOFT RUBBER HARD RUBBER HARD RUBBER POLYOLEFIN POLY-U ON POLY-O (GRAY/BEIGE) POLY-U ON POLY-O (GRAY/BEIGE) THERMAL PLASTIC RUBBER THERMAL PLASTIC RUBBER PHENOLIC YOKE AXLE & NUT	NYLON BALL NYLON BALL PLAIN PLAIN BALL PLAIN BALL STL DSW -	170 170 250 250 250 250 250 250 250 250 250	3-1/4	4-15/16	WC3840-**-SR WC3840-**-SRB WC3840-**-HR WC3840-**-HRB WC3840-**-HDP WC3840-**-PPPG WC3840-**-PPBG WC3840-**-TRP WC3840-**-TRB WC3840-**-PHN WC3840-**-YAN	WC3840R-**-SR WC3840R-**-SRB WC3840R-**-HR WC3840R-**-HRB WC3840R-**-HDP WC3840R-**-PPPG WC3840R-**-PPBG WC3840R-**-TRP WC3840R-**-TRB WC3840R-**-PHN WC3840R-**-YAN
5	1-1/4	SOFT RUBBER SOFT RUBBER HARD RUBBER HARD RUBBER POLYOLEFIN POLY-U ON POLY-O (GRAY/BEIGE) POLY-U ON POLY-O (GRAY/BEIGE) THERMAL PLASTIC RUBBER THERMAL PLASTIC RUBBER ROUND THERMAL PLASTIC RUBBER PHENOLIC YOKE AXLE & NUT	NYLON BALL NYLON BALL PLAIN PLAIN BALL PLAIN BALL GRAPHITE STL DSW -	200 200 250 250 250 250 250 250 250 250 250 250	3-3/4	5-3/4	WC3850-**-SR WC3850-**-SRB WC3850-**-HR WC3850-**-HRB WC3850-**-HDP WC3850-**-PPPG WC3850-**-PPBG WC3850-**-TRP WC3850-**-TRB WC3850-**-RTPO WC3850-**-PHN WC3850-**-YAN	WC3850R-**-SR WC3850R-**-SRB WC3850R-**-HR WC3850R-**-HRB WC3850R-**-HDP WC3850R-**-PPPG WC3850R-**-PPBG WC3850R-**-TRP WC3850R-**-TRB WC3850R-**-RTPO WC3850R-**-PHN WC3850R-**-YAN



WC 3800 SERIES

FASTENERS FOR WC 3800 SERIES		
TYPE	CODE	SIZE
TOP PLATE	01	OVERALL SIZE: 2-1/2 x 3-3/4 BOLT HOLE PATTERN: 1-3/4 x 2-7/8 SLOTTED TO 3 ATTACHING BOLT SIZE: 5/16
TOP PLATE	02	OVERALL SIZE: 3-3/4 x 4-1/2 BOLT HOLE PATTERN: 2-5/8 x 3-5/8 SLOTTED TO 3 x 3 ATTACHING BOLT SIZE: 3/8
TOP PLATE	03	OVERALL SIZE: 3-1/8 x 4-1/8 BOLT HOLE PATTERN: 1-3/4 x 3 SLOTTED TO 2-3/8 x 3-3/8 ATTACHING BOLT SIZE: 3/8
TOP PLATE	04	OVERALL: 1-3/4 x 3 HOLE SPACING: 1 x 2-3/16 SLOTTED TO 2-5/16 ATTACHING BOLT SIZE: 5/16
GRIP RING STEM	11 12 17	A x B 7/16 x 1-1/2 .845 x 2-3/16 7/16 x 2
THREADED STEM	21 22 24 26N	A-B x C 1/2-13 x 1 1/2-13 x 1-1/2 3/8-16 x 1-1/4 1/2-13 x 2-13/16
OCTAGON STEM	41B 42	3/4 x 2-1/8 WITH 3 CROSS DRILLED HOLES 7/8 x 2 WITH 5/16" CROSS DRILLED HOLE 1" UP

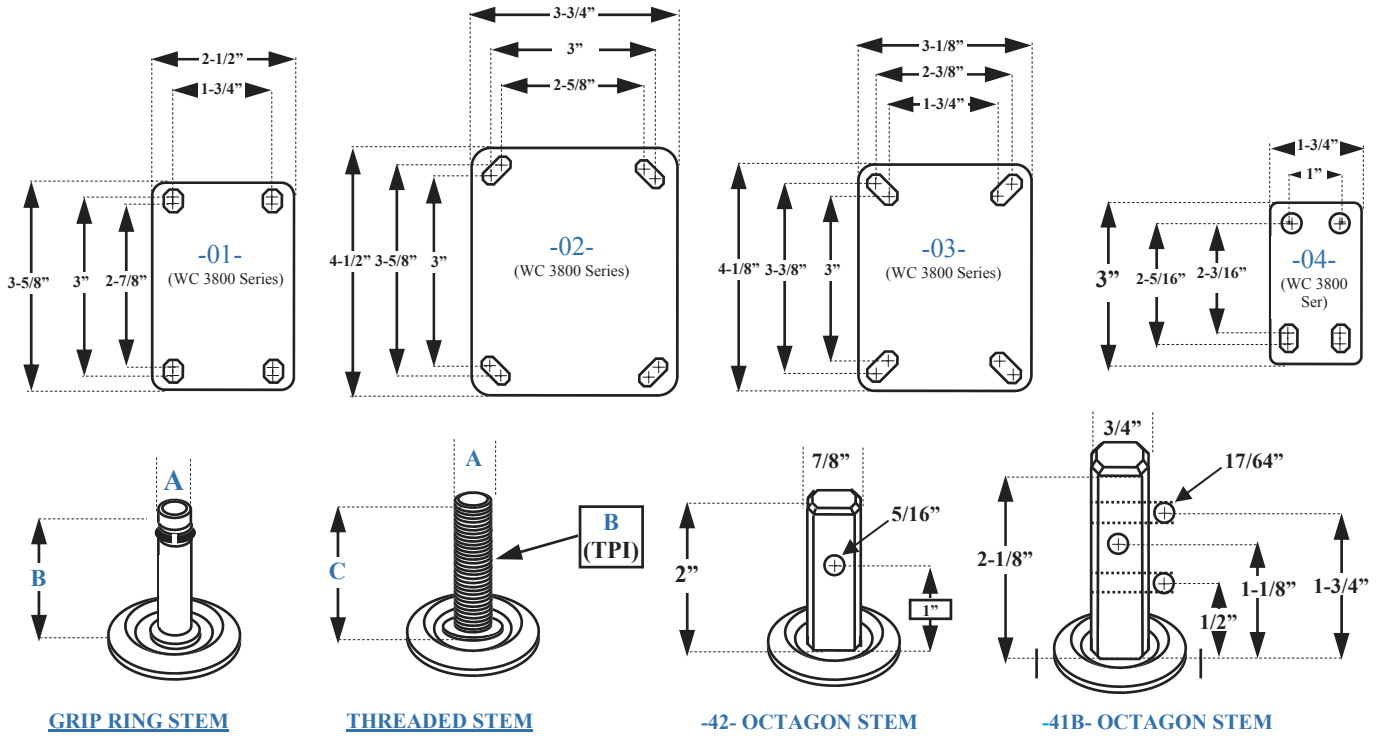

OPTIONS FOR WC 3800 SERIES (Add option abbreviation to end of the caster part #)

OLD STYLE TLB
AVAILABLE ON 3" ONLY



TLB

INTEGRATED TLB
AVAILABLE ON
2", 2.5", 4", 5"



TLB

THREAD GAURDS
(USE WITH BB)



TG

BEARING COVER
(FOR: PPB*, TRB)



BCG

PEDAL WHEEL BRAKE
Available on 5"



PWB

QUICK CHANGE
PLATE FOR 01 T.P.
(FOR SWIVEL
CASTERS ONLY).

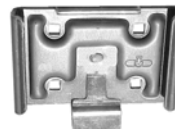

RIVETED
AXLE
(FACTORY
ORDER)



RA

SPECIAL FINISHES
(FACTORY ORDER)

POLISHED GOLD FINISH	PGF
BLACK OXIDE	BO
NICKLE	N
CHROME	CR

#QCP-01-5200 (ZINC, BOLT-ON TYPE)
QCP-01-5200-UNPLATED (WELD-ON)

WC 4000 SERIES



- Capacity to 300 lbs.
- Most economical casters for unlimited, light-duty applications.
- Large single-ball raceways deeply embossed for strength and durability.
- Integrated top lock brakes provide a sure lock without interfering with the roll-ability of the wheel when disengaged, unlike side-lock style brakes.
- Applications: Displays, dollies, platforms, racks, rolling tool boxes, food service, etc.
- Economy revision available in the 3”.

WHEEL	WHEEL	WHEEL	WHEEL	WHEEL	WHEEL	WHEEL	SWIVEL #	RIGID #
2	15/16	SOFT RUBBER HARD RUBBER STEEL (CAST IRON) POLYOLEFIN POLY-U/ POLY-O (GRAY ON BEIGE) YOKE ,AXLE & NUT	NYLON NYLON PLAIN PLAIN PLAIN -	90 150 150 150 120 150	2	2-1/2	WC4020-01-SR WC4020-01-HR WC4020-01-STL WC4020-01-LDP WC4020-01-PPPG WC4020-01-YAN	WC4020R-01-SR WC4020R-01-HR WC4020R-01-STL WC4020R-01-LDP WC4020R-01-PPPG WC4020R-01-YAN
2-1/2	1-1/8	SOFT RUBBER HARD RUBBER LIGHT DUTY POLYOLEFIN HEAVY DUTY POLYOLEFIN POLY-U ON POLY-O THERMAL PLASTIC RUBBER STEEL (CAST IRON) YOKE AXLE & NUT	NYLON NYLON PLAIN PLAIN OILLESS OILLESS PLAIN -	120 160 160 200 160 150 200 200	2-3/8	3-1/8	WC4025-01-SR WC4025-01-HR WC4025-01-LDP WC4025-01-HDP WC4025-01-PPOR WC4025-01-TRO WC4025-01-STL WC4025-01-YAN	WC4025R-01-SR WC4025R-01-HR WC4025R-01-LDP WC4025R-01-HDP WC4025R-01-PPOR WC4025R-01-TRO WC4025R-01-STL WC4025R-01-YAN
3	1-1/4	SOLID POLYURETHANE GRAY SOFT RUBBER SOFT RUBBER SOFT RUBBER HARD RUBBER HARD RUBBER LIGHT DUTY POLYOLEFIN HEAVY DUTY POLYOLEFIN HEAVY DUTY POLYOLEFIN POLY-U / POLY-O (GRAY ON BEIGE) POLY-U / POLY-O (BLUE ON GRAY) POLY-U/ POLY-O (GRAY ON BEIGE) PHENOLIC THERMAL PLASTIC RUBBER THERMAL PLASTIC RUBBER STEEL (CAST IRON) RUBBER ON ALUMINUM POLYURETHANE ON ALUMINUM YOKE AXLE & NUT	DELTRIN NYLON NYLON BALL NYLON BALL PLAIN PLAIN BALL BALL PLAIN STL DSW PLAIN BALL PLAIN ANNULAR ANNULAR -	250 150 150 150 220 220 250 250 250 250 250 250 165 165 250 250 250 250 250	3	3-3/4	WC4030-01-SPU WC4030-01-GSR WC4030-01-SR WC4030-01-SRB WC4030-01-HR WC4030-01-HRB WC4030-01-LDP WC4030-01-HDP WC4030-01-HDPB WC4030-01-PPBG WC4030-01-PPBL WC4030-01-PPPG WC4030-01-PHN WC4030-01-TRP WC4030-01-TRB WC4030-01-STL WC4030-01-RAL WC4030-01-PAL WC4030-01-YAN	WC4030R-01-SPU WC4030R-01-GSR WC4030R-01-SR WC4030R-01-SRB WC4030R-01-HR WC4030R-01-HRB WC4030R-01-LDP WC4030R-01-HDP WC4030R-01-HDPB WC4030R-01-PPBG WC4030R-01-PPBL WC4030R-01-PPPG WC4030R-01-PHN WC4030R-01-TRP WC4030R-01-TRB WC4030R-01-STL WC4030R-01-RAL WC4030R-01-PAL WC4030R-01-YAN
4	1-1/2 1-1/2 1-1/2 1-1/2 1-5/8	SOFT RUBBER HARD RUBBER POLY-U / POLY-O (RED-ORANGE / GRAY) STEEL (CAST IRON) POLYOLEFIN YOKE AXLE & NUT	NYLON NYLON STL SPAN STL SPAN STL SPAN -	225 300 300 300 300 300	3-3/8	5	WC4040-01-SR WC4040-01-HR WC4040-01-XLOGO WC4040-01-STL WC4040-01-XDPO WC4040-01-YAN	WC4040R-01-SR WC4040R-01-HR WC4040R-01-XLOGO WC4040R-01-STL WC4040R-01-XDPO WC4040R-01-YAN



WC 4000 SERIES

FASTENERS FOR WC 4000 SERIES			
WHEEL DIAMETER	OVERALL SIZE	BOLT HOLE PATTERN	BOLT SIZE
SWIVEL:			
2	1-7/8 x 2-9/16	15/16 x 2-1/8	1/4
2-1/2	2-3/4 x 3-7/8	1-3/4 x 3	5/16
3	3-1/8 x 4-1/8	2-3/8 x 3-3/8 SLOTTED TO 3-7/16	5/16
4	4 x 5-1/8	3 x 4	3/8
RIGID:			
2	1-1/2 x 2-21/32	15/16 x 2-1/8	1/4
2-1/2	2-1/4 x 4-7/16	1-1/16 x 3-1/2	5/16
3	2-1/2 x 4-15/16	1-3/16 x 4	5/16
4	3-1/8 x 6-1/4	1-3/4 x 5	3/8

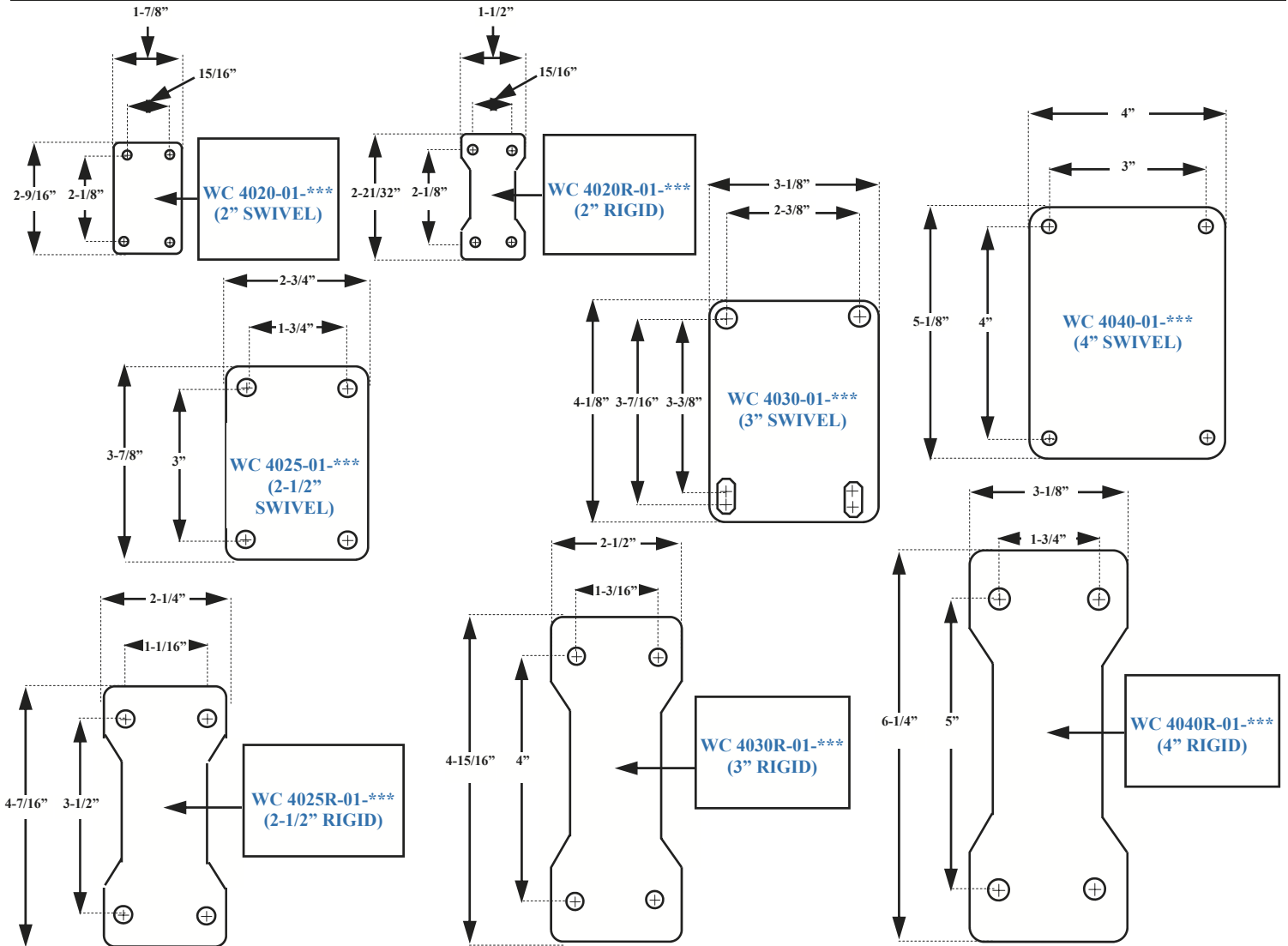

OPTIONS FOR WC 4000 SERIES (Add option abbreviation to end of the caster part #)

INTEGRATED TLB
AVAILABLE ON 2", 2.5", 3"



TLB

THREAD GAURDS
(USE W/BEARING)



TG

BEARING COVER
(FOR: PPB®, TRB)



BCG

PEDAL WHEEL BRAKE
Available on 3"



PWB

RIVETED
AXLE
(FACTORY
ORDER)



RA

SPECIAL FINISHES
(FACTORY ORDER)

POLISHED GOLD FINISH	PGF
BLACK OXIDE	BO
NICKLE	N
CHROME	CR

WC 4900 SERIES



- Capacity to 250 lbs.
- 3/8" axle and nut used instead of rivet. (5/16 axle available upon request)
- Zinc plated.
- Sealed upper raceway helps keep out dirt and dust.
- Case hardened double ball raceways provide extra capacity & durability.
- Applications: Shopping carts, miscellaneous carts and racks, food service & institutional equipment, etc.

WHEEL	WHEEL	WHEEL	WHEEL	WHEEL	WHEEL	WHEEL	REPLACE ** WITH FASTENER CODE)
							SWIVEL #
5	1-1/4	SOFT RUBBER	NYLON	200	3-7/8	5-15/16	WC 4950-**-SR
		SOFT RUBBER	BALL	200			WC 4950-**-SRB
		HARD RUBBER	NYLON	250			WC 4950-**-HR
		HARD RUBBER	BALL	250			WC 4950-**-HRB
		POLYOLEFIN	PLAIN	250			WC 4950-**-HDP
		POLY-U / POLY-O (RED ON GRAY)	BALL	250			WC 4950-**-PPBR
		POLY-U / POLY-O (GRAY ON BEIGE)	BALL	250			WC 4950-**-PPBG
		POLY-U / POLY-O (BLACK ON GRAY)	BALL	250			WC 4950-**-PPBK
		POLY-U / POLY-O (BLUE ON GRAY)	BALL	250			WC 4950-**-PPBL
		POLY-U / POLY-O (GRAY ON BEIGE)	PLAIN	250			WC 4950-**-PPPG
		THERMAL PLASTIC RUBBER	BALL	250			WC 4950-**-TRB
		THERMAL PLASTIC RUBBER	PLAIN	250			WC 4950-**-TRP
		ROUND THERMAL PLASTIC RUBBER	GRAPHITE	250			WC 4950-**-RTPO
		RUBBER ON ALUMINUM	ANNULAR	250			WC 4950-**-RAL
		POLYURETHANE ON ALUMINUM	ANNULAR	250			WC 4950-**-PAL
		YOKE AXLE & NUT	-	250			WC 4950-**-YAN

FASTENERS FOR WC 4900 SERIES

TYPE	CODE	SIZE
GRIP RING STEM	12	.845 x 2-3/16
THREADED STEM WITH KEYLOCK	20	1/2-13 x 3/4
	21	1/2-13 x 9/16
	22	1/2-13 x 7/8
HANDTRUCK STEM	33	1 x 2-7/16 WITH A 13/32 CROSS DRILLED HOLE, 1" UP
OCTAGON STEM	43	7/8 x 1-7/8 WITH 1/2 CROSS DRILLED HOLE, 1" UP CENTERED

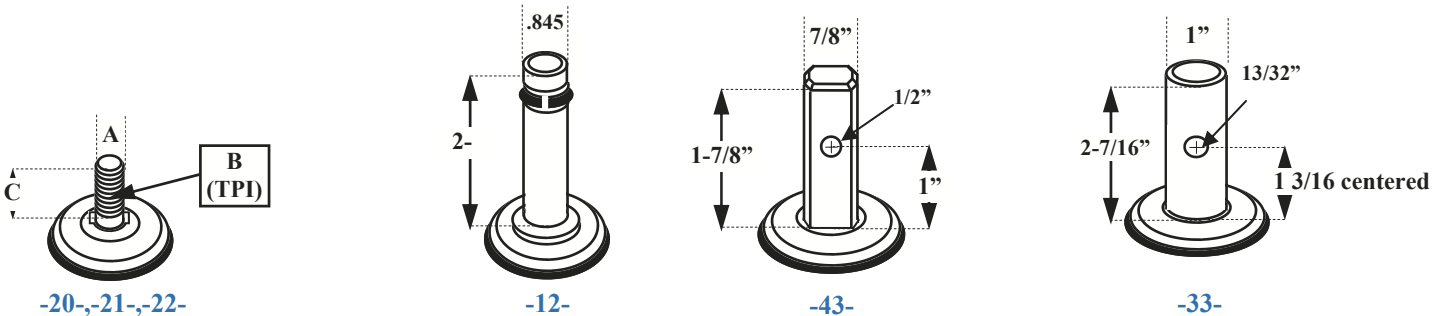

OPTIONS FOR WC 4900 SERIES (Add option abbreviation to end of the caster part #)

PEDAL WHEEL



PWB

INTEGRATED TLB



TLB

THREAD GUARDS (USE WITH BB)



TG

BEARING COVER (FOR: PPB*, TRB)



BCG









WC 5000 SERIES



- Capacity up to 350 lbs.
- Yoke is stamped and drawn from heavily embossed steel.
- Case hardened double ball raceways provide extra capacity & durability
- 1/2" king pin is hydraulically upset to increase shock absorbing capacity.
- Large variety of fasteners for various applications.
- Very durable, economical caster for hundreds of applications
- Applications: Light-medium duty material handling equipment, food service carts & equipment, bakery racks & equipment, institutional carts & equipment, miscellaneous dollies, mobile cases, displays, mobile wire racking, stock carts, textile applications, warehouse & manufacturing applications, etc.

WHEEL	SWIVEL #	RIGID #	REPLACE ** WITH FASTENER CODE				
			SWIVEL #	RIGID #			
3	1-1/4	SOLID POLYURETHANE SOFT RUBBER SOFT RUBBER HARD RUBBER HARD RUBBER PHENOLIC POLYOLEFIN POLYOLEFIN STEEL (CAST IRON) POLY-U / POLY-O (GRAY ON BEIGE) POLY-U / POLY-O (GRAY ON BEIGE) THERMAL PLASTIC RUBBER THERMAL PLASTIC RUBBER RUBBER ON ALUMINUM POLYURETHANE ON ALUMINUM YOKE AXLE & NUT	DELRIN NYLON BALL NYLON BALL STL DSW PLAIN BALL PLAIN BALL PLAIN ANNULAR ANNULAR -	300 150 150 250 250 350 300 300 300 250 250 210 210 250 350 350	3 4	WC5030-**-SPU WC5030-**-SR WC5030-**-SRB WC5030-**-HR WC5030-**-HRB WC5030-**-PHN WC5030-**-HDP WC5030-**-HDPB WC5030-**-STL WC5030-**-PPBG WC5030-**-PPPG WC5030-**-TRB WC5030-**-TRP WC5030-**-RAL WC5030-**-PAL WC5030-**-YAN	WC5030R-**-SPU WC5030R-**-SR WC5030R-**-SRB WC5030R-**-HR WC5030R-**-HRB WC5030R-**-PHN WC5030R-**-HDP WC5030R-**-HDPB WC5030R-**-STL WC5030R-**-PPBG WC5030R-**-PPPG WC5030R-**-TRB WC5030R-**-TRP WC5030R-**-RAL WC5030R-**-PAL WC5030R-**-YAN
3-1/2	1-1/4	SOLID POLYURETHANE SOFT RUBBER HARD RUBBER POLYOLEFIN POLY-U / POLY-O (GRAY ON BEIGE) POLY-U / POLY-O (BLACK ON GRAY) POLY-U / POLY-O (BLUE ON GRAY) POLY-U / POLY-O (GRAY ON BEIGE) THERMAL PLASTIC RUBBER THERMAL PLASTIC RUBBER RUBBER ON ALUMINUM POLYURETHANE ON ALUMINUM YOKE AXLE & NUT	DELRIN NYLON NYLON PLAIN BALL BALL BALL PLAIN BALL PLAIN ANNULAR ANNULAR -	350 160 275 300 250 250 250 250 250 250 250 250 350 350	3-1/8 4-5/8	WC5035-**-SPU WC5035-**-SR WC5035-**-HR WC5035-**-HDP WC5035-**-PPBG WC5035-**-PPBK WC5035-**-PPBL WC5035-**-PPPG WC5035-**-TRB WC5035-**-TRP WC5035-**-RAL WC5035-**-PAL WC5035-**-YAN	WC5035R-**-SPU WC5035R-**-SR WC5035R-**-HR WC5035R-**-HDP WC5035R-**-PPBG WC5035R-**-PPBK WC5035R-**-PPBL WC5035R-**-PPPG WC5035R-**-TRB WC5035R-**-TRP WC5035R-**-RAL WC5035R-**-PAL WC5035R-**-YAN
4	1-1/4	SOLID POLYURETHANE SOFT RUBBER SOFT RUBBER HARD RUBBER HARD RUBBER GRAY HARD RUBBER HIGH TEMP GLASS FILLED NYLON HIGH TEMP PHENOLIC PHENOLIC POLYOLEFIN STEEL (CAST IRON) POLY-U / POLY-O (GRAY ON BEIGE) POLY-U / POLY-O (BLACK ON GRAY) POLY-U / POLY-O (BLUE ON GRAY) POLY-U / POLY-O (GRAY ON BEIGE) THERMAL PLASTIC RUBBER THERMAL PLASTIC RUBBER RUBBER ON ALUMINUM POLYURETHANE ON ALUMINUM YOKE AXLE & NUT	DELRIN NYLON BALL NYLON BALL PLAIN STEEL STEEL STL DSW PLAIN STEEL BALL BALL BALL PLAIN BALL PLAIN ANNULAR ANNULAR -	350 170 170 275 275 255 350 350 350 300 350 275 275 275 275 250 250 250 350 350	3-1/2 5	WC5040-**-SPU WC5040-**-SR WC5040-**-SRB WC5040-**-HR WC5040-**-HRB WC5040-**-GHR WC5040-**-HTGFN WC5040-**-HTPHN WC5040-**-PHN WC5040-**-HDP WC5040-**-STL WC5040-**-PPBG WC5040-**-PPBK WC5040-**-PPBL WC5040-**-PPPG WC5040-**-TRB WC5040-**-TRP WC5040-**-RAL WC5040-**-PAL WC5040-**-YAN	WC5040R-**-SPU WC5040R-**-SR WC5040R-**-SRB WC5040R-**-HR WC5040R-**-HRB WC5040R-**-GHR WC5040R-**-HTGFN WC5040R-**-HTPHN WC5040R-**-PHN WC5040R-**-HDP WC5040R-**-STL WC5040R-**-PPBG WC5040R-**-PPBK WC5040R-**-PPBL WC5040R-**-PPPG WC5040R-**-TRB WC5040R-**-TRP WC5040R-**-RAL WC5040R-**-PAL WC5040R-**-YAN

WC 5000 SERIES

							(REPLACE ** WITH FASTENER CODE)	
							SWIVEL #	RIGID #
5	1-1/4	SOLID POLYURETHANE	DELTRIN	350	4	6-3/16	WC5050-**-SPU	WC5050R-**-SPU
		SOFT RUBBER	NYLON	200			WC5050-**-SR	WC5050R-**-SR
		HARD RUBBER	BALL	200			WC5050-**-SRB	WC5050R-**-SRB
		HARD RUBBER	NYLON	280			WC5050-**-HR	WC5050R-**-HR
		PHENOLIC	BALL	280			WC5050-**-HRB	WC5050R-**-HRB
		HIGH TEMP GLASS FILLED NYLON	STEEL	350			WC5050-**-PHN	WC5050R-**-PHN
		POLYOLEFIN	STEEL	350			WC5050-**-HTGFN	WC5050R-**-HTGFN
		POLY-U / POLY-O (GRAY ON BEIGE)	PLAIN	325			WC5050-**-HDP	WC5050R-**-HDP
		POLY-U / POLY-O (BLACK ON GRAY)	BALL	300			WC5050-**-PPBG	WC5050R-**-PPBG
		POLY-U / POLY-O (BLUE ON GRAY)	BALL	300			WC5050-**-PPBK	WC5050R-**-PPBK
		POLY-U/ POLY-O (GRAY ON BEIGE)	BALL	300			WC5050-**-PPBL	WC5050R-**-PPBL
		THERMAL PLASTIC RUBBER	PLAIN	300			WC5050-**-PPPG	WC5050R-**-PPPG
		THERMAL PLASTIC RUBBER	BALL	250			WC5050-**-TRB	WC5050R-**-TRB
		ROUND THERMAL PLASTIC RUBBER	PLAIN	250			WC5050-**-TRP	WC5050R-**-TRP
		RUBBER ON ALUMINUM	GRAPHITE	250			WC5050-**-RTPO	WC5050R-**-RTPO
		POLYURETHANE ON ALUMINUM	ANNULAR	250			WC5050-**-RAL	WC5050R-**-RAL
YOKE AXLE & NUT	ANNULAR	350	WC5050-**-PAL	WC5050R-**-PAL				
	-	350	WC5050-**-YAN	WC5050R-**-YAN				
6	1-1/4	SOLID POLYURETHANE	DELTRIN	350	4-1/2	7-3/8	WC5060-**-SPU	WC5060R-**-SPU
		POLY-U / POLY-O (GRAY ON BEIGE)	BALL	325			WC5060-**-PPBG	WC5060R-**-PPBG
		THERMAL PLASTIC RUBBER	BALL	300			WC5060-**-TRB	WC5060R-**-TRB
		YOKE AXLE & NUT	-	350			WC5060-**-YAN	WC5060R-**-YAN

FASTENERS FOR WC 5000 SERIES		
FASTENER TYPE	CODE	SIZE
TOP PLATE	01	OVERALL SIZE: 2-1/2 x 3-5/8 BOLT HOLE PATTERN: 1-3/4 x 2-7/8 SLOTTED TO 3 ATTACHING BOLT SIZE: 5/16
TOP PLATE	02	OVERALL SIZE: 3-3/4 x 4-1/2 BOLT HOLE PATTERN: 2-5/8 x 3-5/8 SLOTTED TO 3 x 3 ATTACHING BOLT SIZE: 3/8
TOP PLATE	03	OVERALL SIZE: 3-1/8 x 4-1/8 BOLT HOLE PATTERN: 1-3/4 x 3 SLOTTED TO 2-3/8 x 3-3/8 ATTACHING BOLT SIZE: 3/8
THREADED STEM (WITH LOWER NUT UNDER RACE- WAY)	21 22	A-B x C 1/2-13 x 1 1/2-13 x 1-1/2
ROUND PLAIN STEM	31	7/8 x 1-7/16 WITH 5/16 CROSS DRILLED HOLE 29/32 UP
OCTAGON STEM	41B 42	3/4 x 2-1/8 WITH 3 CROSS DRILLED HOLES 7/8 x 2 WITH 5/16 CROSS DRILLED HOLE 1" UP

WC 5000 SERIES

FASTENER DIAGRAMS

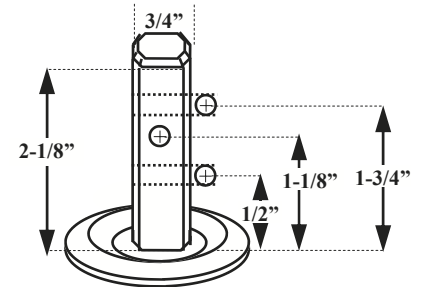
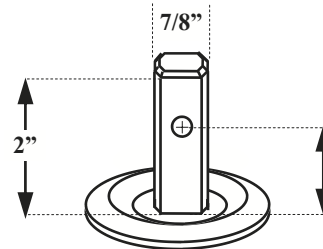
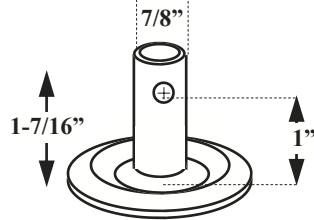
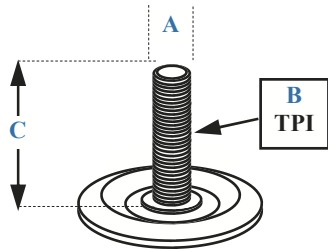
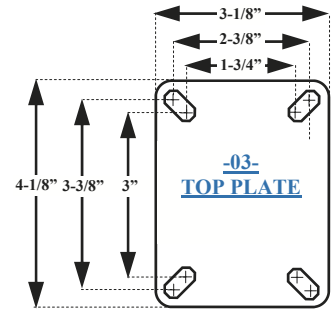
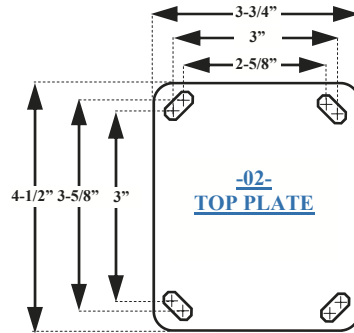
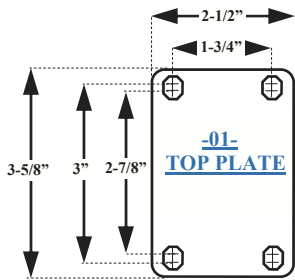

OPTIONS FOR WC 5000 SERIES (Add option abbreviation to end of the caster part #)

INTEGRATED TLB



TLB

THREAD GAURDS (USE WITH BB)



TG

RIVETED AXLE (FACTORY ORDER)



RA

SPECIAL FINISHES (FACTORY ORDER)

POLISHED GOLD FINISH	PGF
BLACK OXIDE	BO
NICKLE	N
CHROME	CR

PEDAL WHEEL BRAKE (Available on 4" only)



PWB

BEARING COVER (FOR: PPB*, TRB)



BCG

ZERK AXLE



Z

QUICK CHANGE PLATE FOR 01 T.P.



#QCP-01-5200 (ZINC, BOLT-ON TYPE)
QCP-01-5200-UNPLATED (WELD-ON)

WC S5000 SERIES



- **Economy Stainless Series: Without seals, grease or zerk fittings. Great for high temperature & economy applications.**
- **304 STAINLESS STEEL (All metal parts are made of Stainless Steel).**
- Highly resistant to conditions that would normally corrode and rust regular steel casters.
- Double ball raceways provide extra capacity & durability
- Applications: Ideal for wet, damp conditions or other corrosive environments such as wash downs, restaurants, food processing plants, hospitals & other institutional applications, etc.

WHEEL	SWIVEL #	RIGID #	REPLACE ** WITH FASTENER CODE					
			SWIVEL #	RIGID #				
3	1-1/4	SOLID POLYURETHANE POLYOLEFIN POLYOLEFIN PHENOLIC POLY-U / POLY-O (GRAY ON BEIGE) POLY-U / POLY-O (GRAY ON BEIGE) THERMAL PLASTIC RUBBER THERMAL PLASTIC RUBBER POLYURETHANE ON ALUMINUM RUBBER ON ALUMINUM YOKE AXLE & NUT	DELTRIN PLAIN SS BALL SS DSW PLAIN SS BALL PLAIN SS BALL ANNULAR ANNULAR -	300 300 300 350 250 250 210 210 350 210 350	3	4	WCS5030-**-SPU WCS5030-**-HDP WCS5030-**-HDP-SB WCS5030-**-PHN WCS5030-**-PPPG WCS5030-**-PPBG-SB WCS5030-**-TRP WCS5030-**-TRB-SB WCS5030-**-PAL WCS5030-**-RAL WCS5030-**-YAN	WCS5030R-**-SPU WCS5030R-**-HDP WCS5030R-**-HDP-SB WCS5030R-**-PHN WCS5030R-**-PPPG WCS5030R-**-PPBG-SB WCS5030R-**-TRP WCS5030R-**-TRB-SB WCS5030R-**-PAL WCS5030R-**-RAL WCS5030R-**-YAN
3-1/2	1-1/4	SOLID POLYURETHANE POLYOLEFIN PHENOLIC POLY-U / POLY-O (GRAY ON BEIGE) POLY-U / POLY-O (GRAY ON BEIGE) THERMAL PLASTIC RUBBER THERMAL PLASTIC RUBBER POLYURETHANE ON ALUMINUM RUBBER ON ALUMINUM YOKE AXLE & NUT	DELTRIN PLAIN SS DSW PLAIN SS BALL PLAIN SS BALL ANNULAR ANNULAR -	350 350 350 250 250 225 225 350 225 350	3-1/8	4-5/8	WCS5035-**-SPU WCS5035-**-HDP WCS5035-**-PHN WCS5035-**-PPPG WCS5030-**-PPBG-SB WCS5035-**-TRP WCS5035-**-TRB-SB WCS5035-**-PAL WCS5035-**-RAL WCS5035-**-YAN	WCS5035R-**-SPU WCS5035R-**-HDP WCS5035R-**-PHN WCS5035R-**-PPPG WCS5030R-**-PPBG-SB WCS5035R-**-TRP WCS5035R-**-TRB-SB WCS5035R-**-PAL WCS5035R-**-RAL WCS5035R-**-YAN
4	1-1/4	SOLID POLYURETHANE POLYOLEFIN HIGH TEMP GLASS FILLED NYLON HIGH TEMP PHENOLIC PHENOLIC POLY-U / POLY-O (GRAY ON BEIGE) POLY-U / POLY-O (GRAY ON BEIGE) THERMAL PLASTIC RUBBER THERMAL PLASTIC RUBBER POLURETHANE ON ALUMINUM RUBBER ON ALUMINUM YOKE AXLE & NUT	DELTRIN PLAIN SS BUSHING SS BUSHING SS DSW PLAIN SS BALL PLAIN SS BALL ANNULAR ANNULAR -	350 300 350 350 350 275 275 250 250 350 250 350	3-1/2	5	WCS5040-**-SPU WCS5040-**-HDP WCS5040-**-HTGFN-Z WCS5040-**-HTPHN-Z WCS5040-**-PHN WCS5040-**-PPPG WCS5040-**-PPBG-SB WCS5040-**-TRP WCS5040-**-TRB-SB WCS5040-**-PAL WCS5040-**-RAL WCS5040-**-YAN	WCS5040R-**-SPU WCS5040R-**-HDP WCS5040R-**-HTGFN-Z WCS5040R-**-HTPHN-Z WCS5040R-**-PHN WCS5040R-**-PPPG WCS5040R-**-PPBG-SB WCS5040R-**-TRP WCS5040R-**-TRB-SB WCS5040R-**-PAL WCS5040R-**-RAL WCS5040R-**-YAN
5	1-1/4	SOLID POLYURETHANE POLYOLEFIN PHENOLIC POLY-U / POLY-O (GRAY ON BEIGE) POLY-U / POLY-O (GRAY ON BEIGE) THERMAL PLASTIC RUBBER THERMAL PLASTIC RUBBER ROUND THERMAL PLASTIC RUBBER POLURETHANE ON ALUMINUM RUBBER ON ALUMINUM YOKE AXLE & NUT	DELTRIN PLAIN SS DSW PLAIN SS BALL PLAIN SS BALL GRAPHITE ANNULAR ANNULAR -	350 325 350 300 300 250 250 250 350 250 350	4	6-3/16	WCS5050-**-SPU WCS5050-**-HDP WCS5050-**-PHN WCS5050-**-PPPG WCS5050-**-PPBG-SB WCS5050-**-TRP WCS5050-**-TRB-SB WCS5050-**-RTPO WCS5050-**-PAL WCS5050-**-RAL WCS5050-**-YAN	WCS5050R-**-SPU WCS5050R-**-HDP WCS5050R-**-PHN WCS5050R-**-PPPG WCS5050R-**-PPBG-SB WCS5050R-**-TRP WCS5050R-**-TRB-SB WCS5050R-**-RTPO WCS5050R-**-PAL WCS5060R-**-RAL WCS5050R-**-YAN
6	1-1/4	SOLID POLYURETHANE POLY-U / POLY-O (GRAY ON BEIGE) THERMAL PLASTIC RUBBER YOKE AXLE & NUT	DELTRIN *BALL W/TG *BALL W/TG -	350 325 300 350	4-1/2	7-3/8	WCS5060-**-SPU WCS5060-**-PPBG WCS5060-**-TRB WCS5060-**-YAN	WCS5060R-**-SPU WCS5060R-**-PPBG WCS5060R-**-TRB WCS5060R-**-YAN

NO STAINLESS BEARINGS AVAILABLE FOR THE PAL/RAL



WC S5000 SERIES

FASTENER DIAGRAMS

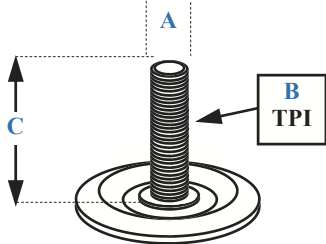
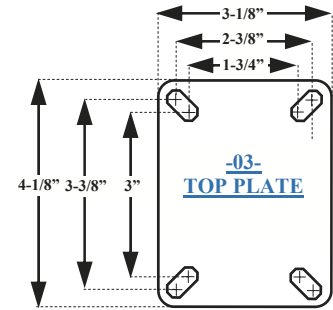
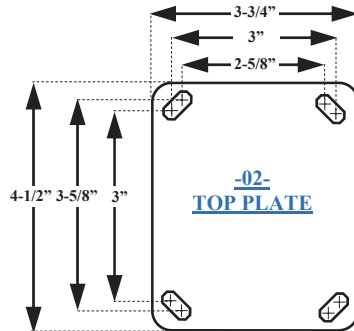
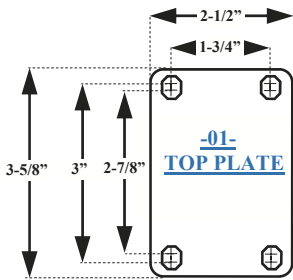

THREADED STEM

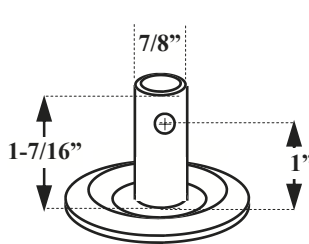

-31- ROUND STEM

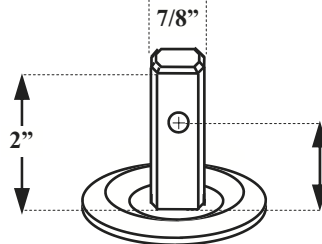

-42- OCTAGON STEM

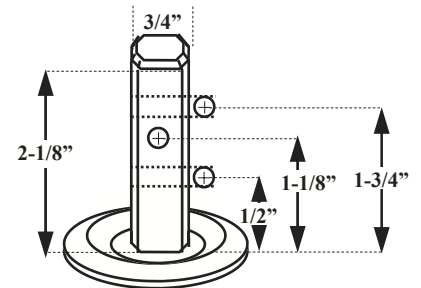

-41B- OCTAGON STEM

FASTENERS FOR WC S5000 SERIES		
FASTENER TYPE	CODE	SIZE
TOP PLATE	01	OVERALL SIZE: 2-1/2 x 3-5/8 BOLT HOLE PATTERN: 1-3/4 x 2-7/8 SLOTTED TO 3 ATTACHING BOLT SIZE: 5/16
TOP PLATE	02	OVERALL SIZE: 3-3/4 x 4-1/2 BOLT HOLE PATTERN: 2-5/8 x 3-5/8 SLOTTED TO 3 x 3 ATTACHING BOLT SIZE: 3/8
TOP PLATE	03	OVERALL SIZE: 3-1/8 x 4-1/8 BOLT HOLE PATTERN: 1-3/4 x 3 SLOTTED TO 2-3/8 x 3-3/8 ATTACHING BOLT SIZE: 3/8
THREADED STEM (WITH LOWER NUT UNDER RACEWAY)	21 22	A-B x C 1/2-13 x 1 1/2-13 x 1-1/2
ROUND PLAIN STEM	31	7/8 x 1-7/16 WITH 5/16 CROSS DRILLED HOLE 29/32 UP
OCTAGON STEM	41B 42	3/4 x 2-1/8 WITH 3 CROSS DRILLED HOLES 7/8 x 2 WITH 5/16 CROSS DRILLED HOLE 1" UP

OPTIONS FOR WC S5000 SERIES (Add option abbreviation to end of the caster part #)

INTEGRATED TLB



TLB

BEARING COVER
(FOR: PPB*, TRB)



BCG

ZERK AXLE



Z

WC 5200 SERIES



- Capacity up to 350 lbs.
- Case hardened double ball raceways provide extra capacity & durability
- Smooth staking of king pin.
- Metal dust cover helps protect swivel raceway.
- Integrated top lock brakes available on both swivel & rigid casters.
- Applications: Light-medium material handling equipment, food service carts & equipment, bakery racks & equipment, institutional carts & equipment, miscellaneous dollies, mobile cases, displays, mobile wire racking, stock carts, textile applications, warehouse & manufacturing applications, etc.

WHEEL	Yoke	WHEEL	Raceway	Swivel	Lock	REPLACE ** WITH FASTENER CODE		
						SWIVEL #	RIGID #	
3	1-1/4	SOLID POLYURETHANE	DELTRIN	300	2-7/8	4-1/16	WC5230-**-SPU	WC5230R-**-SPU
		SOFT RUBBER	NYLON	150			WC5230-**-SR	WC5230R-**-SR
		SOFT RUBBER	BALL	150			WC5230-**-SRB	WC5230R-**-SRB
		HARD RUBBER	NYLON	250			WC5230-**-HR	WC5230R-**-HR
		HARD RUBBER	BALL	250			WC5230-**-HRB	WC5230R-**-HRB
		PHENOLIC	STL DSW	350			WC5230-**-PHN	WC5230R-**-PHN
		POLYOLEFIN	PLAIN	300			WC5230-**-HDP	WC5230R-**-HDP
		POLYOLEFIN	BALL	300			WC5230-**-HDPB	WC5230R-**-HDPB
		STEEL (CAST IRON)	PLAIN	300			WC5230-**-STL	WC5230R-**-STL
		POLY-U / POLY-O (GRAY ON BEIGE)	BALL	250			WC5230-**-PPBG	WC5230R-**-PPBG
		POLY-U / POLY-O (BLUE ON GRAY)	BALL	250			WC5230-**-PPBL	WC5230R-**-PPBL
		POLY-U / POLY-O (GRAY ON BEIGE)	PLAIN	250			WC5230-**-PPPG	WC5230R-**-PPPG
		THERMAL PLASTIC RUBBER	BALL	210			WC5230-**-TRB	WC5230R-**-TRB
		THERMAL PLASTIC RUBBER	PLAIN	210			WC5230-**-TRP	WC5230R-**-TRP
		RUBBER ON ALUMINUM	ANNULAR	250			WC5230-**-RAL	WC5230R-**-RAL
		POLYURETHANE ON ALUMINUM	ANNULAR	350			WC5230-**-PAL	WC5230R-**-PAL
		YOKE AXLE & NUT	-	350			WC5230-**-YAN	WC5230R-**-YAN
3-1/2	1-1/4	SOLID POLYURETHANE	DELTRIN	350	3-1/4	4-5/8	WC5235-**-SPU	WC5235R-**-SPU
		SOFT RUBBER	NYLON	160			WC5235-**-SR	WC5235R-**-SR
		HARD RUBBER	NYLON	275			WC5235-**-HR	WC5235R-**-HR
		POLYOLEFIN	PLAIN	300			WC5235-**-HDP	WC5235R-**-HDP
		POLY-U / POLY-O (GRAY ON BEIGE)	BALL	250			WC5235-**-PPBG	WC5235R-**-PPBG
		POLY-U / POLY-O (BLACK ON GRAY)	BALL	250			WC5235-**-PPBK	WC5235R-**-PPBK
		POLY-U / POLY-O (BLUE ON GRAY)	BALL	250			WC5235-**-PPBL	WC5235R-**-PPBL
		POLY-U / POLY-O (GRAY ON BEIGE)	PLAIN	250			WC5235-**-PPPG	WC5235R-**-PPPG
		THERMAL PLASTIC RUBBER	BALL	250			WC5235-**-TRB	WC5235R-**-TRB
		THERMAL PLASTIC RUBBER	PLAIN	250			WC5235-**-TRP	WC5235R-**-TRP
		RUBBER ON ALUMINUM	ANNULAR	250			WC5235-**-RAL	WC5235R-**-RAL
		POLYURETHANE ON ALUMINUM	ANNULAR	350			WC5235-**-PAL	WC5235R-**-PAL
YOKE AXLE & NUT	-	350	WC5235-**-YAN	WC5235R-**-YAN				
4	1-1/4	SOLID POLYURETHANE	DELTRIN	350	3-1/2	5-1/8	WC5240-**-SPU	WC5240R-**-SPU
		SOFT RUBBER	NYLON	170			WC5240-**-SR	WC5240R-**-SR
		SOFT RUBBER	BALL	170			WC5240-**-SRB	WC5240R-**-SRB
		HARD RUBBER	NYLON	275			WC5240-**-HR	WC5240R-**-HR
		HARD RUBBER	BALL	275			WC5240-**-HRB	WC5240R-**-HRB
		GRAY HARD RUBBER	PLAIN	255			WC5240-**-GHR	WC5240R-**-GHR
		HIGH TEMP GLASS FILLED NYLON	STEEL	350			WC5240-**-HTGFN	WC5240R-**-HTGFN
		HIGH TEMP PHENOLIC	STEEL	350			WC5240-**-HTPHN	WC5240R-**-HTPHN
		PHENOLIC	STL DSW	350			WC5240-**-PHN	WC5240R-**-PHN
		POLYOLEFIN	PLAIN	300			WC5240-**-HDP	WC5240R-**-HDP
		STEEL (CAST IRON)	STEEL	350			WC5240-**-STL	WC5240R-**-STL
		POLY-U / POLY-O (GRAY ON BEIGE)	BALL	275			WC5240-**-PPBG	WC5240R-**-PPBG
		POLY-U / POLY-O (BLACK ON GRAY)	BALL	275			WC5240-**-PPBK	WC5240R-**-PPBK
		POLY-U / POLY-O (BLUE ON GRAY)	BALL	275			WC5240-**-PPBL	WC5240R-**-PPBL
		POLY-U / POLY-O (GRAY ON BEIGE)	PLAIN	275			WC5240-**-PPPG	WC5240R-**-PPPG
		THERMAL PLASTIC RUBBER	BALL	250			WC5240-**-TRB	WC5240R-**-TRB
		THERMAL PLASTIC RUBBER	PLAIN	250			WC5240-**-TRP	WC5240R-**-TRP
		RUBBER ON ALUMINUM	ANNULAR	250			WC5240-**-RAL	WC5240R-**-RAL
		POLYURETHANE ON ALUMINUM	ANNULAR	350			WC5240-**-PAL	WC5240R-**-PAL
YOKE AXLE & NUT	-	350	WC5240-**-YAN	WC5240R-**-YAN				



WC 5200 SERIES

		WHEEL				REPLACE ** WITH FASTENER CODE		
						SWIVEL #	RIGID #	
5	1-1/4	SOLID POLYURETHANE	DELTRIN	350	4	6-3/16	WC5250-**-SPU	WC5250R-**-SPU
		SOFT RUBBER	NYLON	200			WC5250-**-SR	WC5250R-**-SR
		HARD RUBBER	BALL	200			WC5250-**-SRB	WC5250R-**-SRB
		HARD RUBBER	NYLON	280			WC5250-**-HR	WC5250R-**-HR
		HARD RUBBER	BALL	280			WC5250-**-HRB	WC5250R-**-HRB
		PHENOLIC	STL DSW	350			WC5250-**-PHN	WC5250R-**-PHN
		HIGH TEMP GLASS FILLED NYLON	STEEL	350			WC5250-**-HTGFN	WC5250R-**-HTGFN
		POLYOLEFIN	PLAIN	325			WC5250-**-HDP	WC5250R-**-HDP
		STEEL (CAST IRON)	STEEL	350			WC5250-**-STL	WC5250R-**-STL
		POLY-U / POLY-O (GRAY ON BEIGE)	BALL	300			WC5250-**-PPBG	WC5250R-**-PPBG
		POLY-U / POLY-O (BLACK ON GRAY)	BALL	300			WC5250-**-PPBK	WC5250R-**-PPBK
		POLY-U / POLY-O (BLUE ON GRAY)	BALL	300			WC5250-**-PPBL	WC5250R-**-PPBL
		POLY-U / POLY-O (GRAY ON BEIGE)	PLAIN	300			WC5250-**-PPPG	WC5250R-**-PPPG
		THERMAL PLASTIC RUBBER	BALL	250			WC5250-**-TRB	WC5250R-**-TRB
THERMAL PLASTIC RUBBER	PLAIN	250	WC5250-**-TRP	WC5250R-**-TRP				
ROUND THERMAL PLASTIC RUBBER	GRAPHITE	250	WC5250-**-RTPO	WC5250R-**-RTPO				
RUBBER ON ALUMINUM	ANNULAR	250	WC5250-**-RAL	WC5250R-**-RAL				
POLYURETHANE ON ALUMINUM	ANNULAR	350	WC5250-**-PAL	WC5250R-**-PAL				
YOKE AXLE & NUT	-	350	WC5250-**-YAN	WC5250R-**-YAN				
6	1-1/4	SOLID POLYURETHANE	DELTRIN	350	4-1/2	7-3/8	WC5260-**-SPU	WC5260R-**-SPU
		POLY-U / POLY-O (GRAY ON BEIGE)	BALL	325			WC5260-**-PPBG-PTG	WC5260R-**-PPBG-PTG
		THERMAL PLASTIC RUBBER	BALL	300			WC5260-**-TRB	WC5260R-**-TRB
		YOKE AXLE & NUT		350			WC5260-**-YAN	WC5260R-**-YAN

FASTENERS FOR 5200 SERIES		
TYPE	CODE	SIZE
TOP PLATE	01	OVERALL SIZE: 2-1/2 x 3-5/8 BOLT HOLE PATTERN: 1-3/4 x 2-7/8 SLOTTED TO 3 ATTACHING BOLT SIZE: 5/16
TOP PLATE	02	OVERALL SIZE: 3-3/4 x 4-1/2 BOLT HOLE PATTERN: 2-5/8 x 3-5/8 SLOTTED TO 3 x 3 ATTACHING BOLT SIZE: 3/8
TOP PLATE	03	OVERALL SIZE: 3-1/8 x 4-1/8 BOLT HOLE PATTERN: 1-3/4 x 3 SLOTTED TO 2-3/8 x 3-3/8 ATTACHING BOLT SIZE: 3/8
TOP PLATE	07	OVERALL SIZE: 3-1/2 x 3-1/2 BOLT HOLE PATTERN: 2-5/8 x 2-5/8 TO 2-3/4 x 2-3/4 ATTACHING BOLT SIZE: 5/16
TOP PLATE (TRIANGULAR PENTAGRAM)	09	SPECS: SEE DRAWING ON NEXT PAGE (PAGE 18)
GRIP RING STEM	11	7/16 x 1-1/2
	12	.845 x 2-3/16
	14	1.48 x 3 WITH DUAL GRIP RINGS
	14CDH	1.48 x 3 WITH DUAL GRIP RINGS W-5/16 CROSS DRILLED HOLE
THREADED STEM (WITH LOWER NUT UNDER RACEWAY)	21	A-B x C 1/2-13 x 1
	22	1/2-13 x 1-1/2
	23	1/2-13 x 2-3/16
	24	1/2-13 x 2-1/4
	26N	1/2-13 x 2-13/16
	58134	5/8-11 x 1-3/4
	34134	3/4-10 x 1-3/4
	344	3/4-10 x 4
PIPE THREAD (NPT)	34PT	THREADED FOR 3/4 PIPE COUPLING x 3/4 LONG
EXPANDABLE ADAPTER STEMS	25	FOR 1-3/8 I.D. 1-1/2 O.D. TUBING
	26	FOR 1-1/2" I.D. 1-5/8 O.D. TUBING
	27	FOR 7/8" I.D. 1" O.D. TUBING
	28	FOR 1" I.D. 1-1/8" O.D. TUBING
	29	FOR 1-1/8" I.D. 1-1/4 O.D. TUBING
ROUND PLAIN STEM	31	7/8 x 1-7/16 WITH 5/16 CROSS DRILLED HOLE 29/32 UP
OCTAGON STEM W/ GRIP RING	41	7/8 x 2-1/4 WITH ONE GRIP RING (TOP)
OCTAGON STEM W/ CROSS DRILLED HOLE	42	7/8 x 2 WITH 5/16 CROSS DRILLED HOLE 1" UP
OCTAGON STEM W/ GROOVE (NO RING)	45	7/8 x 2-1/4 (GROOVE WITH NO GRIP RING)
SQUARE STEM	51	7/8 x 2 WITH 1/4" CROSS DRILLED HOLE 1" UP
ROUND STEM FOR ADJUSTABLE LEG	61	1-1/4" x 4" WITH A 3/4" THREADED HOLE 3-3/4" DEEP.
	62	1-1/4" x 2" WITH A 3/4" THREADED HOLE 1-1/4" DEEP.

SEE
FASTENER
DIAGRAMS
& OPTIONS
ON THE
NEXT PAGE
(P.18)

WC 5200 SERIES

OPTIONS FOR WC 5200 SERIES (Add option abbreviation to end of the caster part #)

PEDAL WHEEL BRAKE
(SWIVELS ONLY)



PWB

INTEGRATED TLB



TLB

THREAD GAURDS
(USE WITH BB)



TG

BEARING COVER
(FOR: PPB*, TRB)



BCG

RACEWAY SEAL &
ZERK FITTING



SLZ

ZERK AXLE



Z

QUICK CHANGE PLATE FOR -01- TOP PLATE
(WILL NOT WORK ON RIGID STAMPED RIGS)



#QCP-01-5200 (ZINC, BOLT-ON TYPE)
QCP-01-5200-UNPLATED (WELD-ON)

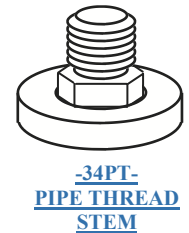
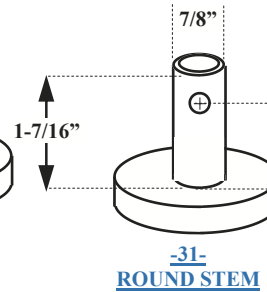
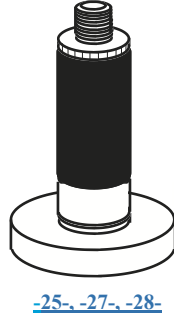
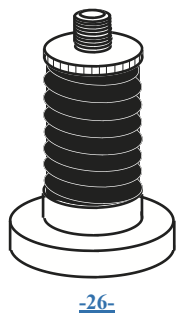
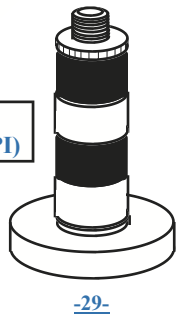
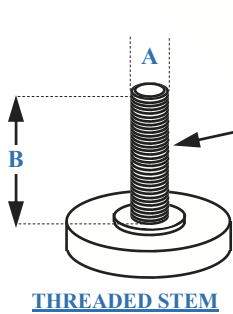
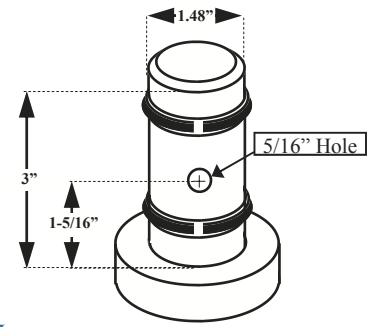
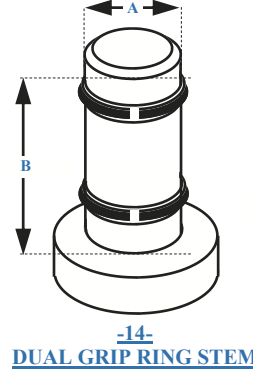
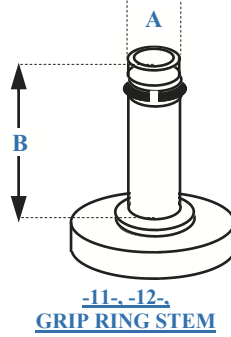
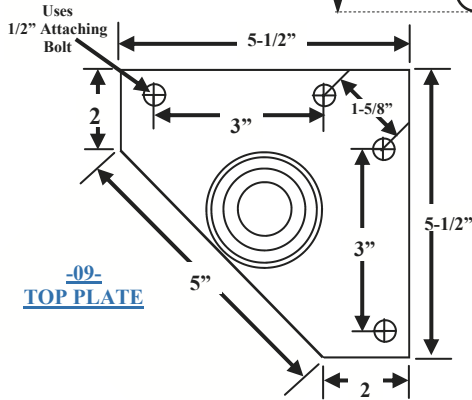
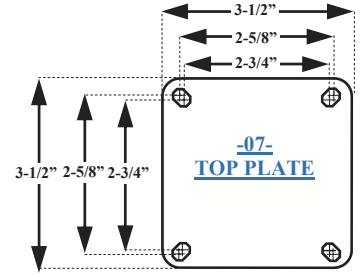
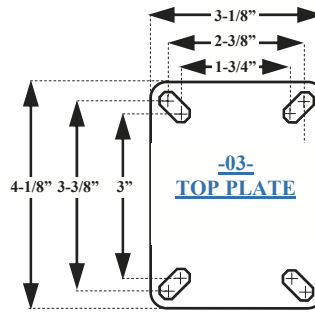
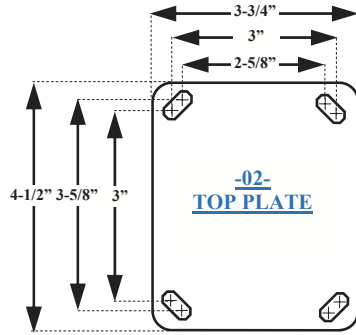
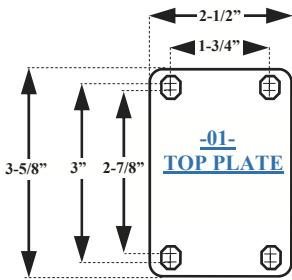

EXPANDABLE ADAPTER STEMS

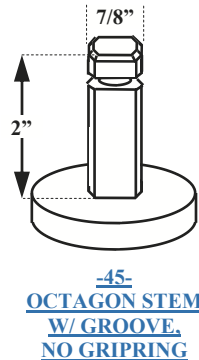
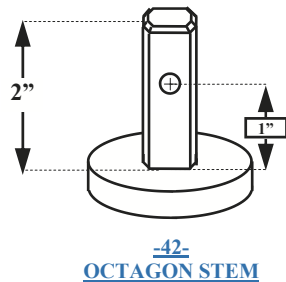
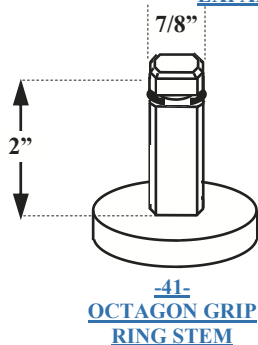

SPECIAL FINISHES (FACTORY ORDER)	
POLISHED	PGF
GOLD FINISH	
BLACK OXIDE	BO
NICKLE	N
CHROME	CR



WC S5200 SERIES



- **304 STAINLESS STEEL.** Highly polished finish provides attractive appearance
- Highly resistant to conditions that would normally corrode and rust regular steel casters.
- Dust cover raceway standard with zerk grease fitting.
- Seals in both the upper and lower raceways standard. **(Not designed for high-temp applications).** Please inquire for alternatives for high-temp applications or use S5000 series (WC S5000 series does not have seals or grease in the raceways).
- Double ball raceways provide extra capacity & durability
- Applications: Ideal for wet, damp conditions or other corrosive environments such as wash downs, restaurants, food processing plants, hospitals & other institutional applications, etc.

WHEEL	WHEEL	WHEEL	WHEEL	WHEEL	WHEEL	REPLACE ** WITH FASTENER CODE		
						SWIVEL #	RIGID #	
3	1-1/4	SOLID POLYURETHANE POLYOLEFIN POLYOLEFIN POLY-U / POLY-O (GRAY ON BEIGE) POLY-U / POLY-O (GRAY ON BEIGE) THERMAL PLASTIC RUBBER THERMAL PLASTIC RUBBER POLYURETHANE ON ALUMINUM RUBBER ON ALUMINUM YOKE AXLE & NUT	DELTRIN PLAIN SS BALL PLAIN SS BALL PLAIN SS BALL ANNULAR ANNULAR -	300 300 300 250 250 210 210 350 250 350	2-7/8	4-1/16	WCS5230-**-SPU WCS5230-**-HDP WCS5230-**-HDP-SB WCS5230-**-PPPG WCS5230-**-PPBG-SB WCS5230-**-TRP WCS5230-**-TRB-SB WCS5230-**-PAL WCS5230-**-RAL WCS5230-**-YAN	WCS5230R-**-SPU WCS5230R-**-HDP WCS5230R-**-HDP-SB WCS5230R-**-PPPG WCS5230R-**-PPBG-SB WCS5230R-**-TRP WCS5230R-**-TRB-SB WCS5230R-**-PAL WCS5230R-**-RAL WCS5230R-**-YAN
3-1/2	1-1/4	SOLID POLYURETHANE POLY-U / POLY-O (GRAY ON BEIGE) POLY-U / POLY-O (GRAY ON BEIGE) THERMAL PLASTIC RUBBER THERMAL PLASTIC RUBBER POLYURETHANE ON ALUMINUM RUBBER ON ALUMINUM YOKE AXLE & NUT	DELTRIN PLAIN SS BALL PLAIN SS BALL ANNULAR ANNULAR -	350 250 250 225 225 350 250 350	3-1/4	4-5/8	WCS5235-**-SPU WCS5235-**-PPPG WCS5235-**-PPBG-SB WCS5235-**-TRP WCS5235-**-TRB-SB WCS5235-**-PAL WCS5235-**-RAL WCS5235-**-YAN	WCS5235R-**-SPU WCS5235R-**-PPPG WCS5235R-**-PPBG-SB WCS5235R-**-TRP WCS5235R-**-TRB-SB WCS5235R-**-PAL WCS5235R-**-RAL WCS5235R-**-YAN
4	1-1/4	SOLID POLYURETHANE POLYOLEFIN POLY-U / POLY-O (GRAY ON BEIGE) POLY-U / POLY-O (GRAY ON BEIGE) THERMAL PLASTIC RUBBER THERMAL PLASTIC RUBBER POLYURETHANE ON ALUMINUM RUBBER ON ALUMINUM YOKE AXLE & NUT	DELTRIN PLAIN PLAIN SS BALL PLAIN SS BALL ANNULAR ANNULAR -	350 300 275 275 250 250 350 250 350	3-1/2	5-1/8	WCS5240-**-SPU WCS5240-**-HDP WCS5240-**-PPPG WCS5240-**-PPBG-SB WCS5240-**-TRP WCS5240-**-TRB-SB WCS5240-**-PAL WCS5240-**-RAL WCS5240-**-YAN	WCS5240R-**-SPU WCS5240R-**-HDP WCS5240R-**-PPPG WCS5240R-**-PPBG-SB WCS5240R-**-TRP WCS5240R-**-TRB-SB WCS5240R-**-PAL WCS5240R-**-RAL WCS5240R-**-YAN
5	1-1/4	SOLID POLYURETHANE POLYOLEFIN POLY-U / POLY-O (GRAY ON BEIGE) POLY-U / POLY-O (GRAY ON BEIGE) THERMAL PLASTIC RUBBER THERMAL PLASTIC RUBBER ROUND THERMAL PLASTIC RUBBER POLYURETHANE ON ALUMINUM RUBBER ON ALUMINUM YOKE AXLE & NUT	DELTRIN PLAIN PLAIN SS BALL PLAIN SS BALL GRAPHITE ANNULAR ANNULAR -	350 325 300 300 250 250 250 350 250 350	4	6-3/16	WCS5250-**-SPU WCS5250-**-HDP WCS5250-**-PPPG WCS5250-**-PPBG-SB WCS5250-**-TRP WCS5250-**-TRB-SB WCS5250-**-RTPO WCS5250-**-PAL WCS5250-**-RAL WCS5250-**-YAN	WCS5250R-**-SPU WCS5250R-**-HDP WCS5250R-**-PPPG WCS5250R-**-PPBG-SB WCS5250R-**-TRP WCS5250R-**-TRB-SB WCS5250R-**-RTPO WCS5250R-**-PAL WCS5250R-**-RAL WCS5250R-**-YAN
6	1-1/4	SOLID POLYURETHANE POLY-U / POLY-O (GRAY ON BEIGE) THERMAL PLASTIC RUBBER YOKE AXLE & NUT	DELTRIN *BALL W/TG *BALL W/TG -	350 325 300 350	4-1/2	7-3/8	WCS5260-**-SPU WCS5260-**-PPBG WCS5260-**-TRB WCS5260-**-YAN	WCS5260R-**-SPU WCS5260R-**-PPBG WCS5260R-**-TRB WCS5260R-**-YAN

OPTIONS FOR WC S5200 SERIES (Add option abbreviation to end of the caster part #)

PEDAL WHEEL BRAKE
(GRAY PEDAL, ALL
STAINLESS PARTS, HEX AXLE)



SPWB

INTEGRATED TLB



TLB

ZERK AXLE



Z

BEARING COVER
(FOR: PPB*, TRB)

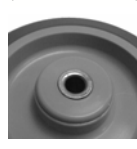

BCG

RACEWAY SEAL &
ZERK FITTING



STANDARD

WC S5200 SERIES CASTERS AVAILABLE
WITHOUT SEALS FOR HIGH-TEMP
APPLICATIONS.
ADD [-WOS] TO THE END OF THE PART #
(EXAMPLE: WCS5250-01-YAN-WOS)

WC S5200 SERIES



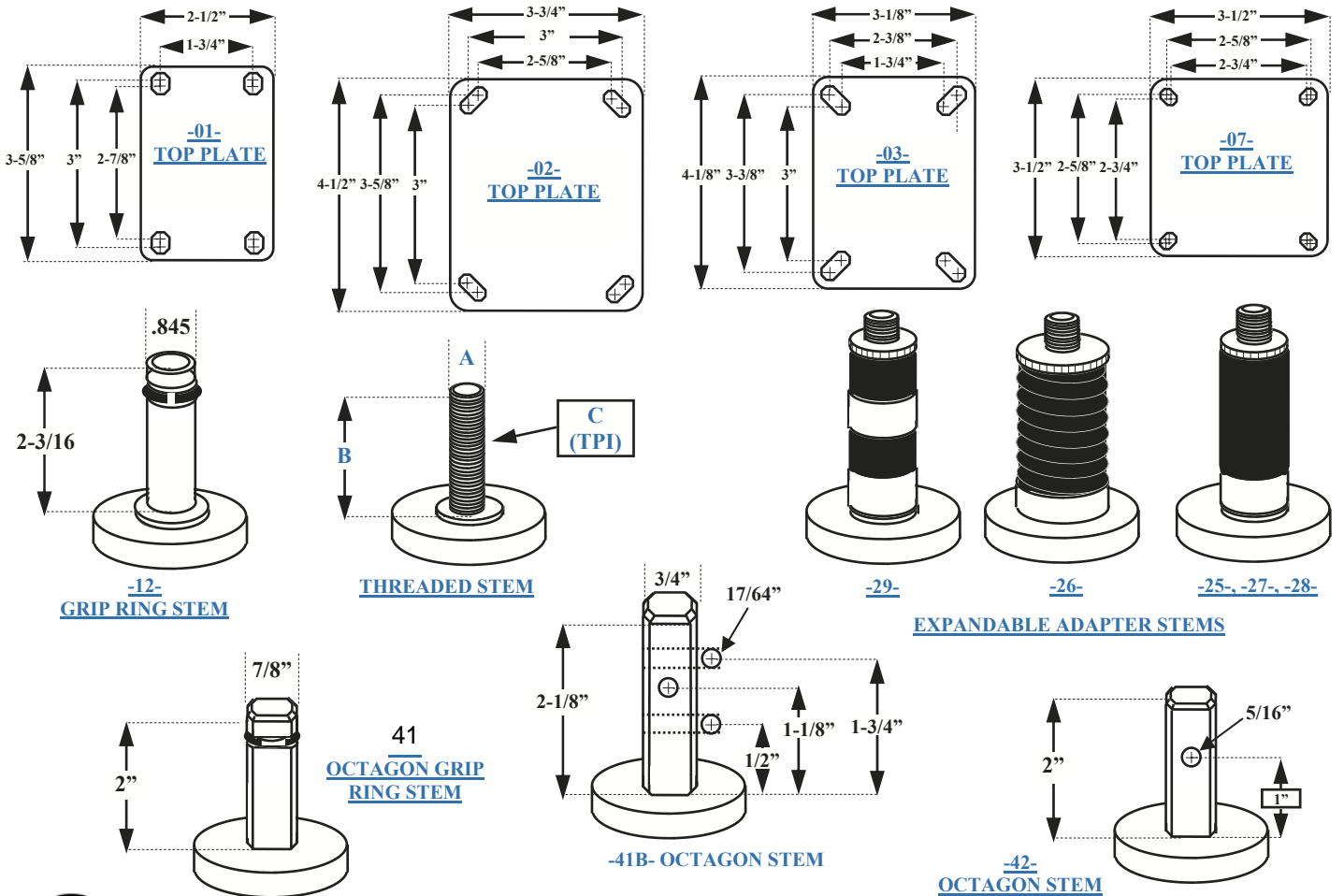



FASTENERS FOR WC S5200 SERIES		
TYPE	CODE	SIZE
TOP PLATE	01	OVERALL SIZE: 2-1/2 x 3-5/8 BOLT HOLE PATTERN: 1-3/4 x 2-7/8 SLOTTED TO 3 ATTACHING BOLT SIZE: 5/16
TOP PLATE	02	OVERALL SIZE: 3-3/4 x 4-1/2 BOLT HOLE PATTERN: 2-5/8 x 3-5/8 SLOTTED TO 3 x 3 ATTACHING BOLT SIZE: 3/8
TOP PLATE	03	OVERALL SIZE: 3-1/8 x 4-1/8 BOLT HOLE PATTERN: 1-3/4 x 3 SLOTTED TO 2-3/8 x 3-3/8 ATTACHING BOLT SIZE: 3/8
TOP PLATE	07	OVERALL SIZE: 3-1/2 x 3-1/2 BOLT HOLE PATTERN: 2-5/8 x 2-5/8 TO 2-3/4 x 2-3/4 ATTACHING BOLT SIZE: 5/16
GRIP RING STEM	12	.845 x 2-3/16
THREADED STEM (WITH LOWER NUT UNDER RACEWAY) (STEM FASTENERS LOWER O.H. BY 3/16")	21 22 23 26N	A-B x C 1/2-13 x 1 1/2-13 x 1-1/2 1/2-13 x 2-3/16 1/2-13 x 2-13/16
EXPANDABLE ADAPTER STEMS	25 26 27 28 29	FOR 1-3/8 I.D. 1-1/2 O.D. TUBING FOR 1-1/2" I.D. 1-5/8 O.D. TUBING FOR 7/8" I.D. 1" O.D. TUBING FOR 1" I.D. 1-1/8" O.D. TUBING FOR 1-1/8" I.D. 1-1/4 O.D. TUBING
OCTAGON STEM	41 41B 42	7/8 x 2-1/4 WITH GRIP RING 3/4 x 2-1/8 WITH 3 CROSS DRILLED HOLES 7/8 x 2 WITH 5/16 CROSS DRILLED HOLE 1" UP



WC 5400 SERIES



- Total lock brake, locks both the wheel and the swivel raceway from turning. Brake activates by stepping on the trailing foot pedal, and deactivates by stepping on the top of the lever.
- Capacity up to 350 lbs.
- Chrome plated finish provides excellent protection and looks great.
- Full thread guards provide protection for the bearings.
- Case hardened double ball raceways provide extra capacity & durability
- Applications: Light-medium material handling equipment, food service carts & equipment, bakery racks & equipment, institutional carts & equipment, miscellaneous dollies, mobile cases, displays, mobile wire racking, stock carts, textile applications, warehouse & manufacturing applications, etc.

							(REPLACE ** WITH FASTENER CODE)
							SWIVEL #
3	1-1/4	THERMAL PLASTIC RUBBER	BALL	180	*3-11/16	4-1/2	WC 5430-**-TRB-TG
4	1-1/4	THERMAL PLASTIC RUBBER	BALL	200		5-1/2	WC 5440-**-TRB-TG
5	1-1/4	THERMAL PLASTIC RUBBER	BALL	220		6-15/32	WC 5450-**-TRB-TG

*Swivel radius is measured to the outside of the brake lever.

FASTENERS FOR WC 5400 SERIES		
TYPE	CODE	SIZE
TOP PLATE	01	OVERALL: 2-1/2 x 3-5/8 HOLE SPACING: 1-3/4 x 2-15/16 ATTACHING BOLT SIZE: 5/16
GRIP RING	11 12 13	7/16 x 1-1/2 .845 x 2-3/16 1 x 2
THREADED STEM	21 23	1/2-13 x 1-1/2 5/8-11 x 1
PLAIN ROUND STEM	31 34	7/8 x 2" with 5/16 cross drilled hole 1-1/8 up 1-1/4 x 2-1/4 cross drilled hole 1-15/32 up

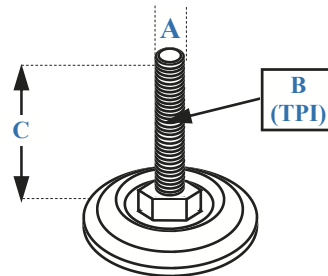
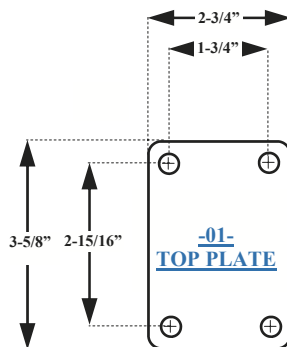

QUICK CHANGE PLATE FOR 01 T.P.



#QCP-01-5200 (ZINC, BOLT-ON TYPE)
QCP-01-5200-UNPLATED (WELD-ON)

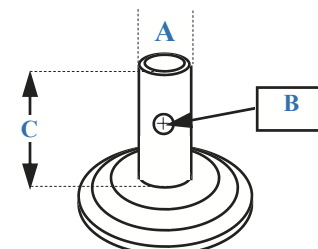
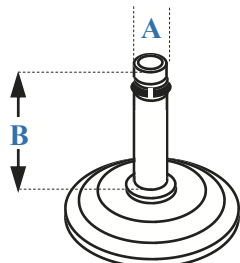

WC 5700 SERIES



- **Economy total-lock series.**
- Built-in total-lock one-step brake system locks down both the swivel and the wheel simultaneously.
- Case hardened double ball raceways provide extra capacity & durability
- Thermal plastic rubber and polyurethane on polyolefin wheels do not mark floors, and come with a single precision ball bearing with integrated spanner bushing & thread guard. Rolls exceptionally well.
- Applications: Movie and soundstage equipment, hospital/medical equipment, computer equipment stands and mobile workstations, electronics and hi-technology equipment and carts, diagnostic equipment, etc.



WHEEL	WHEEL	WHEEL	WHEEL	WHEEL	WHEEL	WHEEL	(REPLACE ** IN PART # WITH THE FASTENER CODE)	
							PLAIN SWIVEL #	RIGID #
3	1-1/4	SOFT RUBBER SOFT RUBBER POLY-U ON POLY-O (RED ON GRAY) POLY-U ON POLY-O (GRAY ON GRAY) POLY-U ON POLY-O (GRAY ON BEIGE) THERMAL PLASTIC RUBBER THERMAL PLASTIC RUBBER THERMAL PLASTIC RUBBER RUBBER ON ALUMINUM POLYURETHANE ON ALUMINUM YOKE AXLE & NUT	NYLON BALL BALL P.BALL PLAIN BALL PLAIN P.BALL ANNULAR ANNULAR -	150 150 250 250 250 210 210 210 240 240 240	4-5/16	4-1/4	WC5730-**-SR WC5730-**-SRB WC5730-**-PPBR WC5730-**-PPSBG WC5730-**-PPPG WC5730-**-TRB WC5730-**-TRP WC5730-**-TRSB WC5730-**-RAL WC5730-**-PAL WC5730-**-YAN	WC5730R-**-SR WC5730R-**-SRB WC5730R-**-PPBR WC5730R-**-PPSBG WC5730R-**-PPPG WC5730R-**-TRB WC5730R-**-TRP WC5730R-**-TRSB WC5730R-**-RAL WC5730R-**-PAL WC5730R-**-YAN
4	1-1/4	SOFT RUBBER SOFT RUBBER POLY-U ON POLY-O (GRAY ON BEIGE) POLY-U ON POLY-O (GRAY ON GRAY) POLY-U ON POLY-O (GRAY ON BEIGE) THERMAL PLASTIC RUBBER THERMAL PLASTIC RUBBER THERMAL PLASTIC RUBBER RUBBER ON ALUMINUM POLYURETHANE ON ALUMINUM YOKE AXLE & NUT	NYLON BALL BALL P.BALL PLAIN BALL PLAIN P.BALL ANNULAR ANNULAR -	170 170 250 250 250 250 250 250 250 250 250	4-5/16	5-1/8	WC5740-**-SR WC5740-**-SRB WC5740-**-PPBG WC5740-**-PPSBG WC5740-**-PPPG WC5740-**-TRB WC5740-**-TRP WC5740-**-TRSB WC5740-**-RAL WC5740-**-PAL WC5740-**-YAN	WC5740R-**-SR WC5740R-**-SRB WC5740R-**-PPBG WC5740R-**-PPSBG WC5740R-**-PPPG WC5740R-**-TRB WC5740R-**-TRP WC5740R-**-TRSB WC5740R-**-RAL WC5740R-**-PAL WC5740R-**-YAN
5	1-1/4	SOFT RUBBER SOFT RUBBER POLY-U ON POLY-O (GRAY ON BEIGE) POLY-U ON POLY-O (GRAY ON GRAY) POLY-U ON POLY-O (GRAY ON BEIGE) THERMAL PLASTIC RUBBER THERMAL PLASTIC RUBBER THERMAL PLASTIC RUBBER ROUND THERMAL PLASTIC RUBBER RUBBER ON ALUMINUM POLYURETHANE ON ALUMINUM YOKE AXLE & NUT	NYLON BALL BALL P.BALL PLAIN BALL PLAIN P.BALL GRAPHITE ANNULAR ANNULAR -	200 200 275 250 275 250 250 250 250 250 275 275	4-5/16	6-3/16	WC5750-**-SR WC5750-**-SRB WC5750-**-PPBG WC5750-**-PPSBG WC5750-**-PPPG WC5750-**-TRB WC5750-**-TRP WC5750-**-TRSB WC5750-**-RTPO WC5750-**-RAL WC5750-**-PAL WC5750-**-YAN	WC5750R-**-SR WC5750R-**-SRB WC5750R-**-PPBG WC5750R-**-PPSBG WC5750R-**-PPPG WC5750R-**-TRB WC5750R-**-TRP WC5750R-**-TRSB WC5750R-**-RTPO WC5750R-**-RAL WC5750R-**-PAL WC5750R-**-YAN

Stainless Steel version available. Call us for more information.

***FOR TOTAL LOCK CASTER, ADD "SWB" TO THE END OF THE PART NUMBER**



WC 5700 SERIES

FASTENERS FOR WC 5700 SERIES		
TYPE	CODE	SIZE
HOLLOW KINGPIN	038 012	FOR (A) 3/8 ATTACHING BOLT FOR (A) 1/2 ATTACHING BOLT
TOP PLATE	01	OVERALL SIZE: 2-5/8 x 3-3/4 BOLT HOLE PATTERN: 1-3/4 x 2-7/8 SLOTTED TO 3 ATTACHING BOLT SIZE: 5/16
TOP PLATE	02	OVERALL SIZE: 3-3/4 x 4-1/2 BOLT HOLE PATTERN: 2-5/8 x 3-5/8 SLOTTED TO 3 x 3 ATTACHING BOLT SIZE: 3/8
TOP PLATE	03	OVERALL SIZE: 3-1/8 x 4-1/8 BOLT HOLE PATTERN: 1-3/4 x 3 SLOTTED TO 2-3/8 x 3-3/8 ATTACHING BOLT SIZE: 3/8
THREADED STEM (WITH LOWER NUT UNDER RACEWAY)	21 22 26N	A-B x C 1/2-13 x 1 1/2-13 x 1-1/2 1/2-13 x 2-11/16
EXPANDABLE ADAPTER STEMS	25 26 27 28 29	FOR 1-3/8 I.D. 1-1/2 O.D. TUBING FOR 1-1/2" I.D. 1-5/8 O.D. TUBING FOR 7/8" I.D. 1" O.D. TUBING FOR 1" I.D. 1-1/8" O.D. TUBING FOR 1-1/8" I.D. 1-1/4 O.D. TUBING

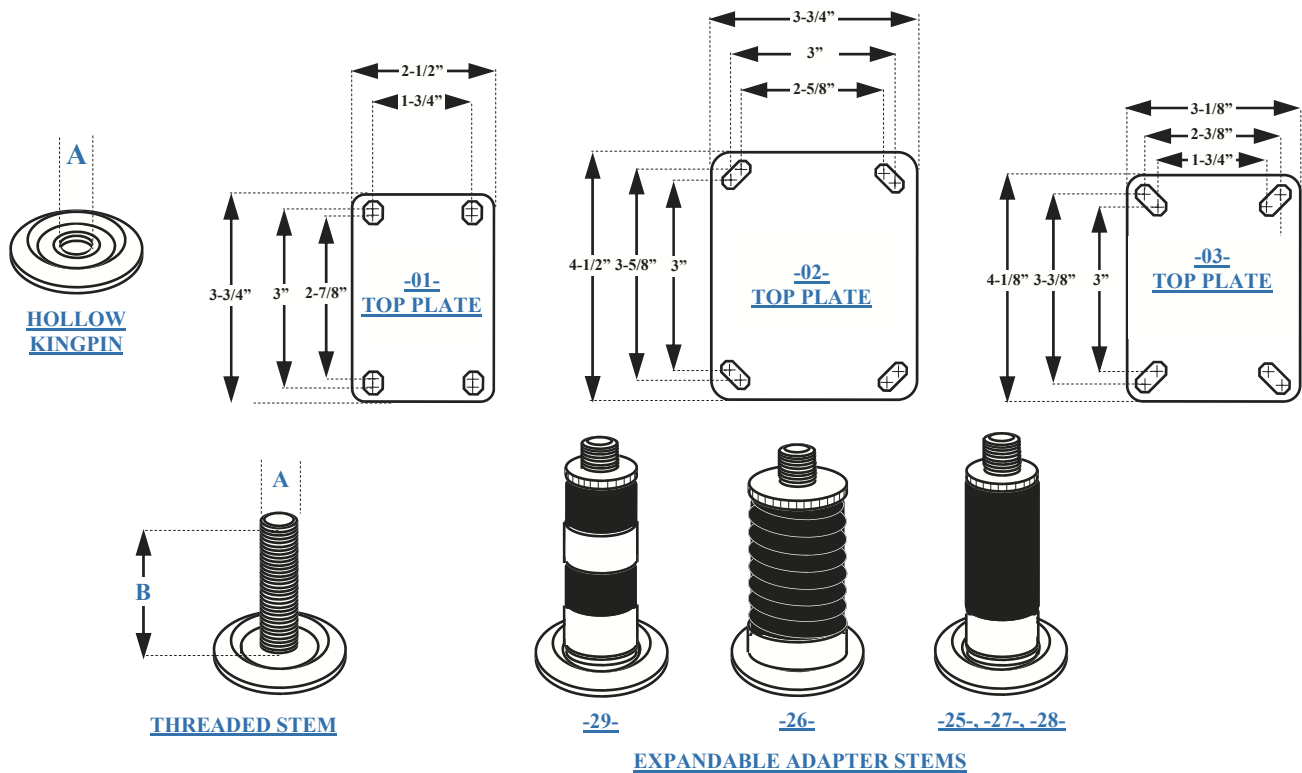

OPTIONS FOR WC 5700 SERIES (Add option abbreviation to end of the caster part #)

BEARING COVER
(FOR: PPB*, TRB)



BCG

THREAD GUARDS
(USE WITH BB)



TG

MATCHING SWIVEL,
NO BRAKE



(REMOVE) -SWB

WC 5500 SERIES



- Capacity up to 400 lbs.
- Case hardened double ball raceways provide extra capacity & durability
- Smooth staking of king pin.
- Metal dust cover helps protect swivel raceway.
- Integrated top lock brakes available on both swivel & rigid casters.
- Applications: Light-medium material handling equipment, food service carts & equipment, bakery racks & equipment, institutional carts & equipment, miscellaneous dollies, mobile cases, displays, mobile wire racking, stock carts, textile applications, warehouse & manufacturing applications, etc.

	WHEEL					REPLACE ** WITH FASTENER CODE	
						SWIVEL #	RIGID #
3	1-13/16	DURAPLAS (POLYOLEFIN) DURAPLAS (POLYOLEFIN) HIGH TEMP GLASS FILLED NYLON HIGH TEMP GLASS FILLED NYLON YOKE AXLE & NUT	OILLESS ROLLER STEEL ROLLER -	500	3-1/16	4-1/16	WC5530-**-XDPO WC5530R-**-XDPO WC5530-**-XDP-RB-Z WC5530R-**-XDP-RB-Z WC5530-**-HTGFN WC5530R-**-HTGFN WC5530-**-HTGFN-RB-Z WC5530R-**-HTGFN-RB-Z WC5530-**-YAN WC5530R-**-YAN
4	1-5/8 1-5/8 1-1/2 1-5/8 1-1/2 1-1/2 1-1/2 1-1/2 1-1/2 1-1/2	SOFT RUBBER DURAPLAS (POLYOLEFIN) DURAPLAS (POLYOLEFIN) HARD RUBBER POLY-U ON POLY-O (BLUE ON BLACK) PHENOLIC RUBBER ON CAST IRON POLYURETHANE ON CAST IRON STEEL (CAST IRON) YOKE AXLE & NUT	OILLESS ROLLER OILLESS ROLLER OILLESS ROLLER OILLESS ROLLER ROLLER ROLLER ROLLER ROLLER ROLLER -	250 400 400 400 400 400 400 400 400 400	3-5/8	5-1/8	WC5540-**-SR WC5540R-**-SR WC5540-**-XDPO WC5540R-**-XDPO WC5540-**-XDP-RB-Z WC5540R-**-XDP-RB-Z WC5540-**-HR WC5540R-**-HR WC5540-**-XLB-Z WC5540R-**-XLB-Z WC5540-**-PHN-Z WC5540R-**-PHN-Z WC5540-**-RCI-Z WC5540R-**-RCI-Z WC5540-**-PCI-Z WC5540R-**-PCI-Z WC5540-**-STL-Z WC5540R-**-STL-Z WC5540-**-YAN WC5540R-**-YAN
5	1-5/8 1-1/2 1-1/2 1-1/2 1-1/2 1-1/2 1-1/2	DURAPLAS (POLYOLEFIN) DURAPLAS (POLYOLEFIN) POLY-U ON POLY-O (BLUE ON BLACK) PHENOLIC RUBBER ON CAST IRON POLYURETHANE ON CAST IRON STEEL (CAST IRON) YOKE AXLE & NUT	OILLESS ROLLER OILLESS ROLLER OILLESS ROLLER OILLESS ROLLER ROLLER ROLLER ROLLER -	400	4	6-3/16	WC5550-**-XDPO WC5550R-**-XDPO WC5550-**-XDP-RB-Z WC5550R-**-XDP-RB-Z WC5550-**-XLB-Z WC5550R-**-XLB-Z WC5550-**-PHN-Z WC5550R-**-PHN-Z WC5550-**-RCI-Z WC5550R-**-RCI-Z WC5550-**-PCI-Z WC5550R-**-PCI-Z WC5550-**-STL-Z WC5550R-**-STL-Z WC5550-**-YAN WC5550R-**-YAN
6	1-5/8 1-1/2 1-1/2 1-1/2 1-1/2 1-1/2 1-1/2 1-1/2 1-1/2	DURAPLAS (POLYOLEFIN) DURAPLAS (POLYOLEFIN) POLY-U ON POLY-O (BLUE ON BLACK) PHENOLIC RUBBER ON CAST IRON POLYURETHANE ON CAST IRON THERMAL PLASTIC RUBBER THERMAL PLASTIC RUBBER STEEL (CAST IRON) YOKE AXLE & NUT	OILLESS ROLLER OILLESS ROLLER OILLESS ROLLER OILLESS ROLLER ROLLER ROLLER ROLLER ROLLER DELTRIN ROLLER -	400	4-1/2	7-1/2	WC5560-**-XDPO WC5560R-**-XDPO WC5560-**-XDP-RB-Z WC5560R-**-XDP-RB-Z WC5560-**-XLB-Z WC5560R-**-XLB-Z WC5560-**-PHN-Z WC5560R-**-PHN-Z WC5560-**-RCI-Z WC5560R-**-RCI-Z WC5560-**-PCI-Z WC5560R-**-PCI-Z WC5560-**-TPR-Z WC5560R-**-TPR-Z WC5560-**-TPR-DB WC5560R-**-TPR-DB WC5560-**-STL-Z WC5560R-**-STL-Z WC5560-**-YAN WC5560R-**-YAN

AXLE SIZE FOR 3", 4" & 5" CASTERS IS 3/8" AXLE SIZE FOR 6" CASTERS IS 1/2".

OPTIONS FOR WC 5500 SERIES (Add option abbreviation to end of the caster part #)

RACEWAY SEAL & ZERK FITTING (FACTORY ORDER)



SLZ

INTEGRATED TLB



TLB

THREAD GAURDS (USE WITH BB)



TG

ZERK AXLE



Z

QUICK CHANGE PLATE FOR 01 T.P.



#QCP-01-5200 (ZINC, BOLT-ON TYPE)
QCP-01-5200-UNPLATED (WELD-ON)

SPECIAL FINISHES (FACTORY ORDER)

POLISHED	PGF
GOLD FINISH	
BLACK OXIDE	BO
NICKLE	N
CHROME	CR



WC 5500 SERIES

FASTENERS FOR WC 5500 SERIES		
TYPE	CODE	SIZE
TOP PLATE	01	OVERALL SIZE: 2-1/2 x 3-5/8 BOLT HOLE PATTERN: 1-3/4 x 2-7/8 SLOTTED TO 3 ATTACHING BOLT SIZE: 5/16
TOP PLATE	02	OVERALL SIZE: 3-3/4 x 4-1/2 BOLT HOLE PATTERN: 2-5/8 x 3-5/8 SLOTTED TO 3 x 3 ATTACHING BOLT SIZE: 3/8
TOP PLATE	03	OVERALL SIZE: 3-1/8 x 4-1/8 BOLT HOLE PATTERN: 1-3/4 x 3 SLOTTED TO 2-3/8 x 3-3/8 ATTACHING BOLT SIZE: 3/8
TOP PLATE	07	OVERALL SIZE: 3-1/2 x 3-1/2 BOLT HOLE PATTERN: 2-5/8 x 2-5/8 TO 2-3/4 x 2-3/4 ATTACHING BOLT SIZE: 5/16
TOP PLATE (TRIANGULAR PENTAGRAM)	09	SPECS: SEE BELOW DRAWING
GRIP RING STEM	12 14 14CDH	A x B .845 x 2-3/16 1.48 x 3 WITH TWO GRIP RINGS (TOP & BOTTOM) 1.48 x 3 WITH TWO GRIP RINGS (TOP & BOTTOM) AND A 5/16 CROSS DRILLED HOLE 1-5/16 UP.
THREADED STEM	21 22 23 24 26N 34134 34PT	A-B x C 1/2-13 x 1 1/2-13 x 1-1/2 1/2-13 x 2-3/16 5/8-11 x 1-3/4 1/2-13 x 2-11/16 3/4-10 x 1-3/4 THREADED FOR 3/4 PIPE COUPLING x 3/4 LONG
EXPANDABLE ADAPTER STEMS	25 to 29	SEE FASTENER CHART FOR 5200 SERIES
ROUND PLAIN STEM	18 31 33	1.48 x 2 WITH A 3/8-24 THREADED, CROSSDRILLED HOLE 1-5/6 UP ON CENTER. 7/8 x 1-7/16 WITH 5/16 CROSS DRILLED HOLE 29/32 UP 1 x 2-7/16 WITH A 13/32 CROSS DRILLED HOLE, 1" UP
OCTAGON STEM	42	7/8 x 2 WITH 5/16 CROSS DRILLED HOLE 1" UP

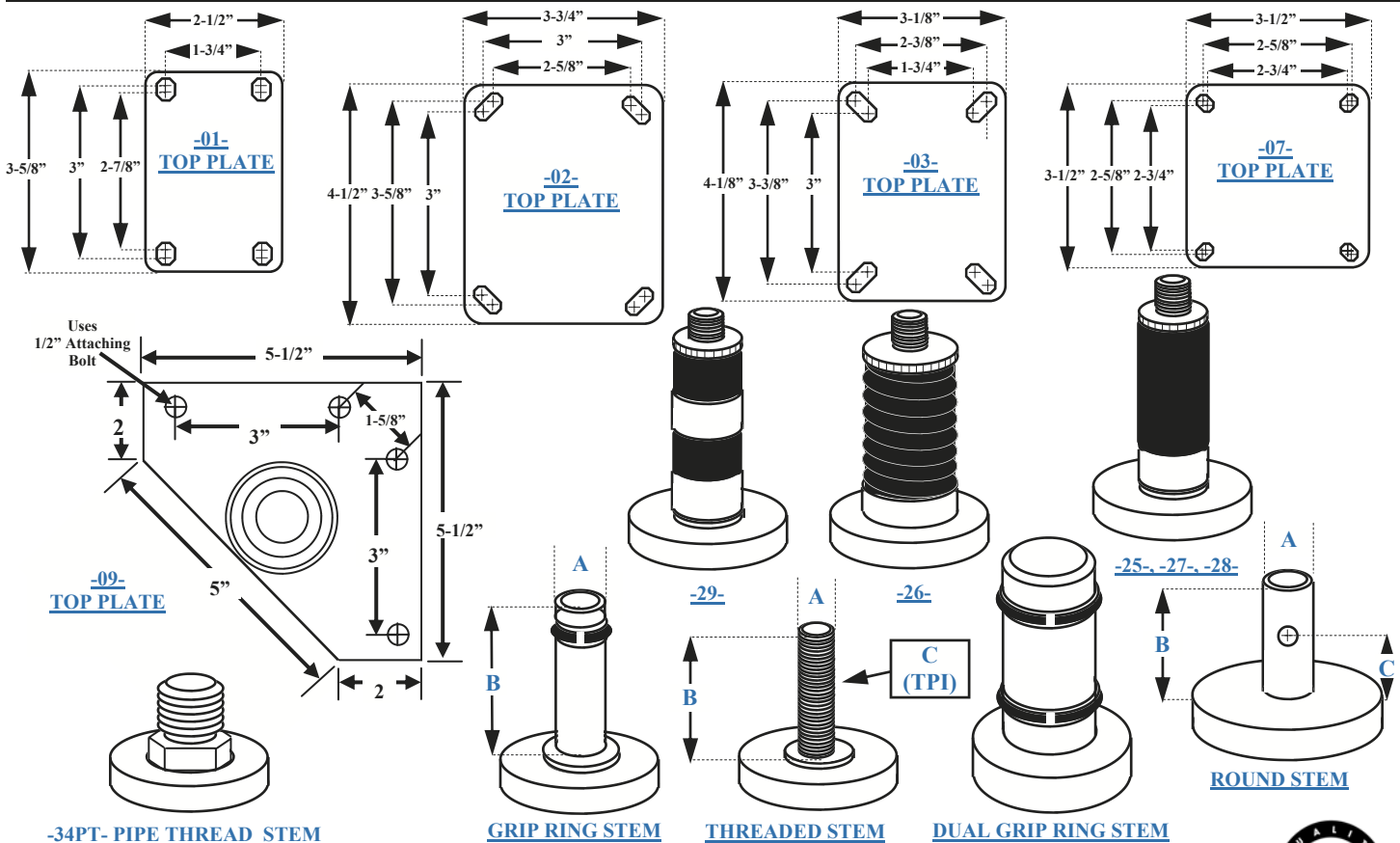

WC 5600 SERIES



- Capacity up to 500 lbs.
- Yoke is cut and stamped from heavily embossed steel.
- Case hardened double ball raceways provide extra capacity & durability
- 1/2" king pin is hydraulically upset to increase shock absorbing capacity.
- Applications: Light-medium duty material handling equipment, food service carts & equipment, bakery racks & equipment, institutional carts & equipment, miscellaneous dollies, mobile cases, displays, mobile wire racking, stock carts, textile applications, warehouse & manufacturing applications, air cargo decks, ground support equipment, conveyors, etc.



WHEEL	AXLE	WHEEL	ROLLER	CAPACITY	AXLE	AXLE	REPLACE ** WITH FASTENER CODE	
							SWIVEL #	RIGID #
2-1/2	1-3/4	DURAPLAS (POLYOLEFIN) DURAPLAS (POLYOLEFIN)	OILLESS ROLLER	400	2-3/8	3-1/2	WC5625-**-XDPO WC5625-**-XDP-RB-Z	WC5625R-**-XDPO WC5625R-**-XDP-RB-Z
3	1-13/16	DURAPLAS (POLYOLEFIN) DURAPLAS (POLYOLEFIN) DURAPLAS (POLYOLEFIN) HIGH TEMP GLASS FILLED NYLON HIGH TEMP GLASS FILLED NYLON HIGH TEMP GLASS FILLED NYLON YOKE AXLE & NUT	OILLESS ROLLER P.BALL STEEL ROLLER P.BALL -	500	2-7/8	3-7/8	WC5630-**-XDPO WC5630-**-XDP-RB-Z WC5630-D4-XDPB-TG-SL WC5630-**-HTGFN WC5630-**-HTGFN-RB-Z WC5630-D4-HTGFNB-TG-SL WC5630-**-YAN	WC5630R-**-XDPO WC5630R-**-XDP-RB-Z N/A WC5630R-**-HTGFN WC5630R-**-HTGFN-RB-Z N/A WC5630R-**-YAN
4	*2	DURAPLAS (POLYOLEFIN) DURAPLAS (POLYOLEFIN) YOKE AXLE & NUT	DELTRIN ROLLER -	375	3-1/8	5	WC5640-**-XDP-DBD WC5640-**-XDP WC5640-**-YAN	WC5640R-**-XDP-DBD WC5640R-**-XDP WC5640R-**-YAN
5	*2	DURAPLAS (POLYOLEFIN) DURAPLAS (POLYOLEFIN) PHENOLIC PHENOLIC POLY-U ON POLY-O (BLUE ON BLACK) POLY-U ON POLY-O (BLUE ON BLACK) RUBBER ON CAST IRON RUBBER ON CAST IRON THERMAL PLASTIC RUBBER THERMAL PLASTIC RUBBER YOKE AXLE & NUT	DELTRIN ROLLER DELTRIN ROLLER DELTRIN ROLLER DELTRIN ROLLER DELTRIN ROLLER -	375	4	6-3/16	WC5650-**-XDP-DBD WC5650-**-XDP WC5650-**-PHN-DBD WC5650-**-PHN WC5650-**-XLB-DBD WC5650-**-XLB WC5650-**-RCI-DBD WC5650-**-RCI WC5650-**-TPR-DBD WC5650-**-TPR WC5650-**-YAN	WC5650R-**-XDP-DBD WC5650R-**-XDP WC5650R-**-PHN-DBD WC5650R-**-PHN WC5650R-**-XLB-DBD WC5650R-**-XLB WC5650R-**-RCI-DBD WC5650R-**-RCI WC5650R-**-TPR-DBD WC5650R-**-TPR WC5650R-**-YAN
6	*2	PNEUMATIC (BLACK) PNEUMATIC (BLACK) PNEUMATIC (GRAY) PNEUMATIC (GRAY) POLYOLEFIN DURAPLAS (POLYOLEFIN) DURAPLAS (POLYOLEFIN) DURAPLAS (POLYOLEFIN) DURAPLAS (POLYOLEFIN) PHENOLIC PHENOLIC POLY-U ON POLY-O (BLUE ON BLACK) POLY-U ON POLY-O (BLUE ON BLACK) RUBBER ON CAST IRON RUBBER ON CAST IRON THERMAL PLASTIC RUBBER THERMAL PLASTIC RUBBER ROUND THERMAL PLASTIC RUBBER ROUND THERMAL PLASTIC RUBBER YOKE AXLE & NUT	BALL ROLLER BALL ROLLER PLAIN PLAIN OILITE DELTRIN ROLLER DELTRIN ROLLER DELTRIN ROLLER DELTRIN ROLLER DELTRIN ROLLER DELTRIN ROLLER DELTRIN ROLLER -	275 275 275 275 375 375 375 375 375 375 375 375 375 375 375 375 375 375 375 375 375 375	4-1/2	7-3/8	WCP5660-**-B-BB WCP5660-**-B-RB WCP5660-**-G-BB WCP5660-**-G-RB WC5660-**-HDP-PB WC5660-**-XDP-PB WC5660-**-XDPO WC5660-**-XDP-DBD WC5660-**-XDP WC5660-**-PHN-DBD WC5660-**-PHN WC5660-**-XLB-DBD WC5660-**-XLB WC5660-**-RCI-DBD WC5660-**-RCI WC5660-**-TPR-DBD WC5660-**-TPR WC5660-**-RTP-DBD WC5660-**-RTP WC5660-**-YAN	WCP5660R-**-B-BB WCP5660R-**-B-RB WCP5660R-**-G-BB WCP5660R-**-G-RB WC5660R-**-HDP-PB WC5660R-**-XDP-PB WC5660R-**-XDPO WC5660R-**-XDP-DBD WC5660R-**-XDP WC5660R-**-PHN-DBD WC5660R-**-PHN WC5660R-**-XLB-DBD WC5660R-**-XLB WC5660R-**-RCI-DBD WC5660R-**-RCI WC5660R-**-TPR-DBD WC5660R-**-TPR WC5660R-**-RTP-DBD WC5660R-**-RTP WC5660R-**-YAN

AXLE SIZE FOR 2-1/2" & 3" CASTERS IS 3/8" AXLE SIZE FOR 4", 5" & 6" CASTERS IS 1/2".



WC 5600 SERIES

FASTENERS FOR WC 5600 SERIES

TYPE	CODE	SIZE
TOP PLATE	01	OVERALL SIZE: 2-1/2 x 3-5/8 BOLT HOLE PATTERN: 1-3/4 x 2-7/8 SLOTTED TO 3 ATTACHING BOLT SIZE: 5/16
TOP PLATE	02	OVERALL SIZE: 3-3/4 x 4-1/2 BOLT HOLE PATTERN: 2-5/8 x 3-5/8 SLOTTED TO 3 x 3 ATTACHING BOLT SIZE: 3/8
TOP PLATE	03	OVERALL SIZE: 3-1/8 x 4-1/8 BOLT HOLE PATTERN: 1-3/4 x 3 to 2-3/8 x 3-3/8 ATTACHING BOLT SIZE: 3/8
TOP PLATE (DIAMOND SHAPE) STANDARD INVERT PLATE. SL, TG & LOWER RACEWAY METAL DUSTCOVER COME STANDARD WITH D4 PLATE.	D4	OVERALL SIZE: 4-5/16 x 3 BOLT HOLE PATTERN: 3-1/2 ON CENTER ATTACHING BOLT SIZE: 7/16
TOP PLATE	07	OVERALL SIZE: 3-1/2 x 3-1/2 BOLT HOLE PATTERN: 2-5/8 x 2-5/8 TO 2-3/4 x 2-3/4 ATTACHING BOLT SIZE: 5/16
GRIP RING STEM	14CDH	1.48 x 3 WITH TWO GRIP RINGS (TOP & BOTTOM) AND A 5/16 CROSS DRILLED HOLE 1-5/16 UP
THREADED STEM	21	A-B x C 1/2-13 x 1
	22	1/2-13 x 1-1/2
	24	5/8-11 x 1-3/4
	25	1/2-13 x 1-3/4
	34134	3/4-10 x 1-3/4
	34PT	THREADED FOR 3/4 PIPE COUPLING x 3/4 LONG
ROUND STEM	33	1 x 2-7/16 WITH A 13/32 CROSS DRILLED HOLE, 1" UP

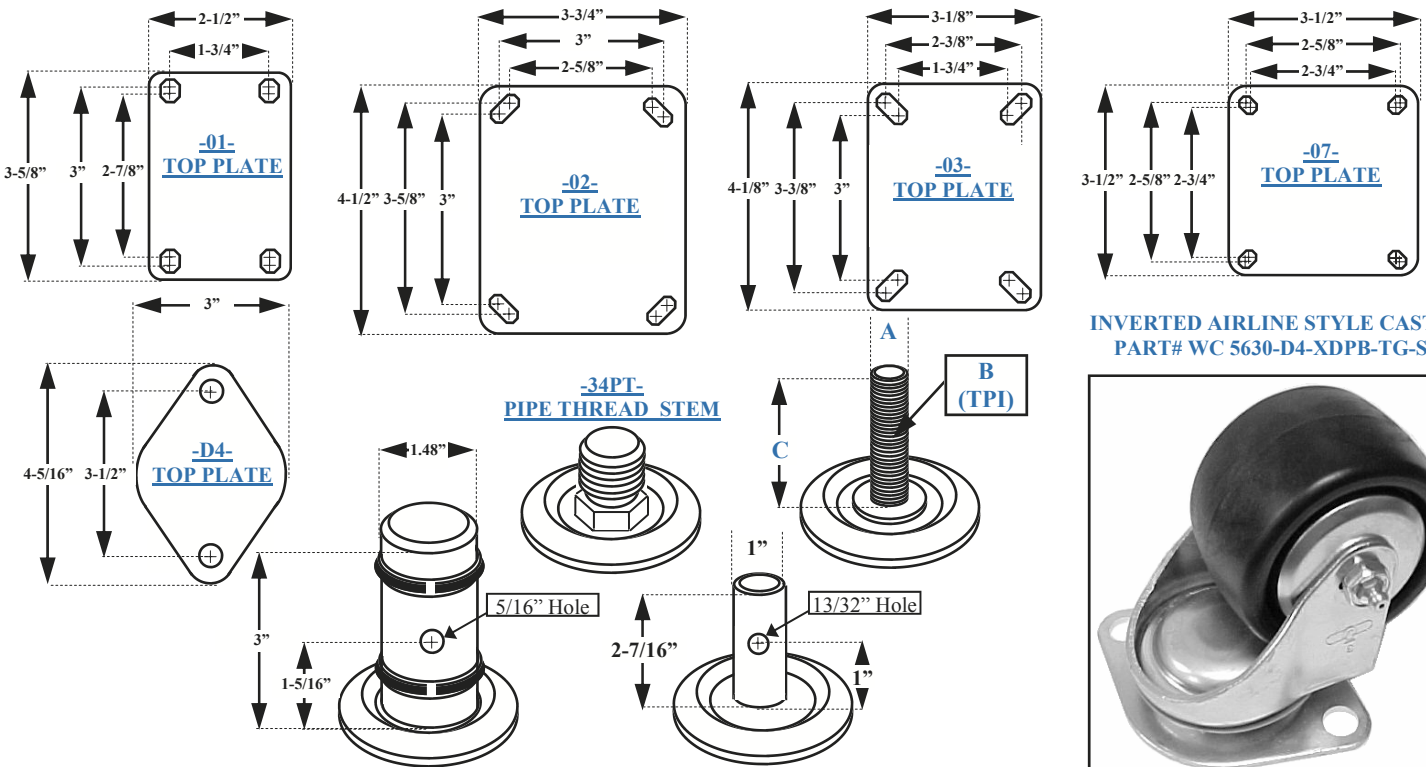

INVERTED AIRLINE STYLE CASTER
PART# WC 5630-D4-XDPB-TG-SL



OPTIONS FOR WC 5600 SERIES (Add option abbreviation to end of the caster part #)

INTEGRATED TLB



TLB

THREAD GAURDS
(USE WITH BB)



TG

ZERK AXLE



Z

QUICK CHANGE
PLATE FOR 01 T.P.



#QCP-01-5200 (ZINC, BOLT-ON TYPE)
QCP-01-5200-UNPLATED (WELD-ON)

SPECIAL FINISHES (FACTORY ORDER)

POLISHED GOLD FINISH	PGF
BLACK OXIDE	BO
NICKLE	N
CHROME	CR

WC 6400 SERIES



- Case hardened double ball raceways provide extra capacity & durability
- Top plate and legs are made out of 1/4" cold forged steel.
- Corrosion-resistant zinc plated finish.
- 5/8" nut and bolt kingpin.
- Zerk grease fittings in axle, swivel bearings and most wheels.
- 2" fork spacing.
- Integrated top lock brakes available on both swivel & rigid casters.
- Applications: Miscellaneous carts, platform trucks, wire shelving units, heavy appliances, general duty material handling, warehouse & factory applications, heavy foodservice & institutional equipment, textile applications, etc.

		WHEEL					SWIVEL #	RIGID #
4	1-1/2	RUBBER ON CAST IRON POLYURETHANE ON CAST IRON POLY-U ON POLY-O (BLUE ON BLACK) POLYOLEFIN STEEL PHENOLIC HIGH-TEMP PHENOLIC V GROOVE YOKE ONLY	ROLLER ROLLER ROLLER ROLLER ROLLER ROLLER ROLLER ROLLER - 750	300 600 500 500 650 600 600 750 750	3-9/16	5-5/8	WC6440-01-RCI WC6440-01-PCI WC6440-01-XLB WC6440-01-HDP WC6440-01-STL WC6440-01-PHN WC6440-01-HTPHN WC6440-01-VG WC6440-01-Y	WC6440R-01-RCI WC6440R-01-PCI WC6440R-01-XLB WC6440R-01-HDP WC6440R-01-STL WC6440R-01-PHN WC6440R-01-HTPHN WC6440R-01-VG WC6440R-01-Y
5	1-1/2	RUBBER ON CAST IRON POLYURETHANE ON CAST IRON POLY-U ON POLY-O (BLUE ON BLACK) POLYOLEFIN STEEL PHENOLIC YOKE ONLY	ROLLER ROLLER ROLLER ROLLER ROLLER ROLLER -	345 750 550 550 700 750 750	4-1/8	6-1/2	WC6450-01-RCI WC6450-01-PCI WC6450-01-XLB WC6450-01-HDP WC6450-01-STL WC6450-01-PHN WC6450-01-Y	WC6450R-01-RCI WC6450R-01-PCI WC6450R-01-XLB WC6450R-01-HDP WC6450R-01-STL WC6450R-01-PHN WC6450R-01-Y
6	1-1/2	RUBBER/CAST IRON POLYURETHANE ON CAST IRON POLY-U ON POLY-O (BLUE ON BLACK) POLYOLEFIN STEEL PHENOLIC THERMAL PLASTIC RUBBER YOKE ONLY	ROLLER ROLLER ROLLER ROLLER ROLLER ROLLER ROLLER -	375 750 600 600 750 750 400 750	4-13/16	7-3/8	WC6460-01-RCI WC6460-01-PCI WC6460-01-XLB WC6460-01-HDP WC6460-01-STL WC6460-01-PHN WC6460-01-TPR WC6460-01-Y	WC6460R-01-RCI WC6460R-01-PCI WC6460R-01-XLB WC6460R-01-HDP WC6460R-01-STL WC6460R-01-PHN WC6460R-01-TPR WC6460R-01-Y

FASTENERS FOR WC 6400 SERIES

FASTENER TYPE	CODE	SIZE
TOP PLATE	01	OVERALL SIZE: 4 x 4-1/2 BOLT HOLE SPACING: 2-5/8 x 3-5/8 SLOTTED TO 3 x 3 ATTACHING BOLT SIZE: 3/8

WC 6400 SERIES

OPTIONS FOR WC 6400 SERIES (Add option abbreviation to end of the caster part #)

INTEGRATED TLB



TLB

INTEGRATED TLB WORKS ON RIGIDS!



TLB

POSITION LOCK



PSL

THREAD GAURDS



TG

RACEWAY SEALS



SL

QUICK CHANGE PLATE "TOOL-LESS"



QCP-01-6600 (ZINC, BOLT-ON TYPE)
QCP-01-6600-UNPLATED (WELD-ON)

SPECIAL FINISHES (FACTORY ORDER)	
POLISHED GOLD FINISH	PGF
BLACK OXIDE	BO
NICKLE	N
CHROME	CR

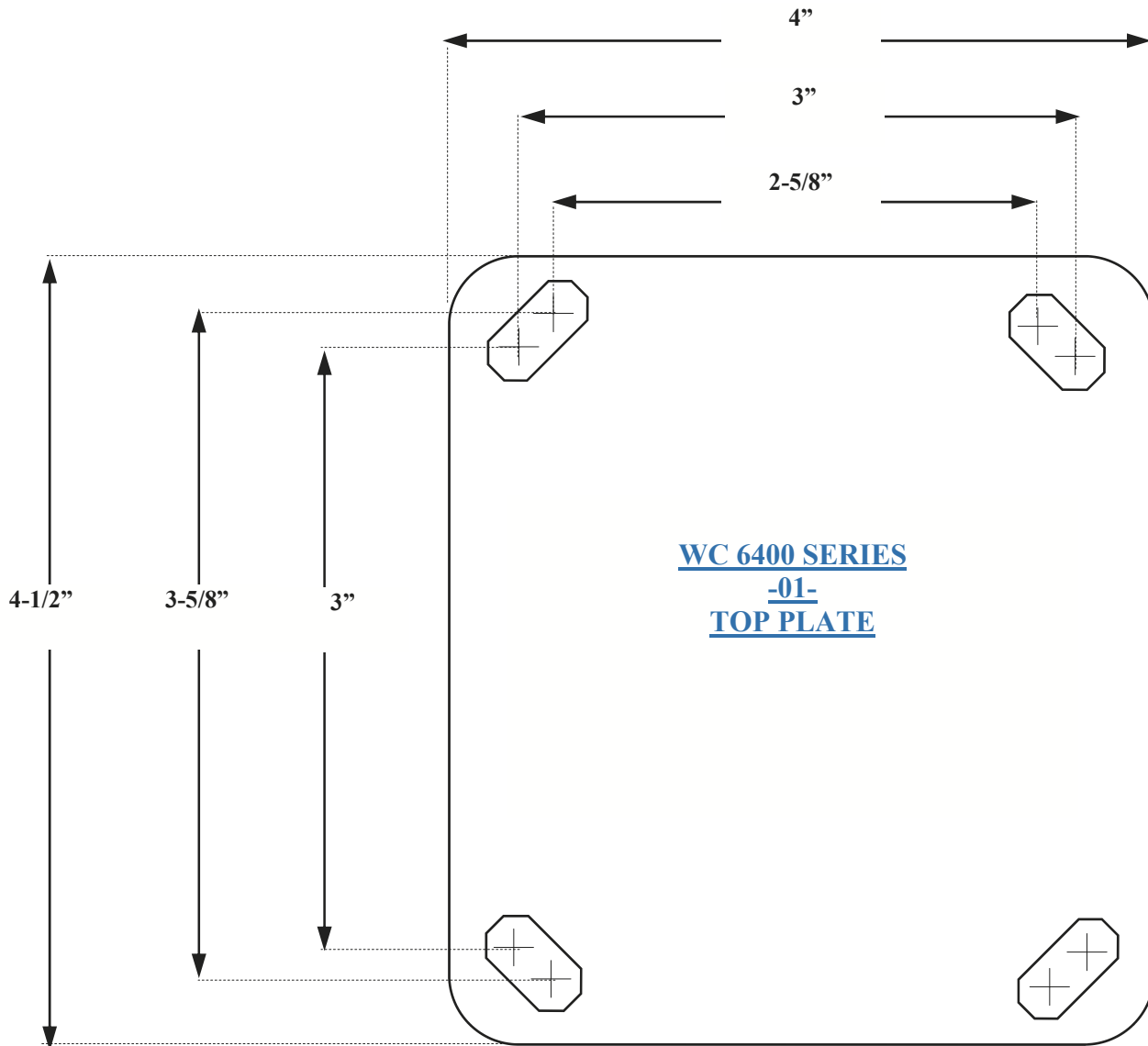

WC 6600 SERIES



- Case hardened double ball raceways provide extra capacity & durability.
- Top plate and legs are made out of 1/4" cold forged steel.
- Corrosion-resistant zinc plated finish.
- 5/8" nut and bolt kingpin, 2-1/2" fork spacing.
- 1/2" zerk axle & lock nut on caster sizes 3-1/4" to 8", 5/8" axle on 3" casters.
- Zerk fittings also in swivel bearings & most wheels.
- Applications: Miscellaneous carts, platform trucks, wire shelving units, heavy appliances, general duty material handling, vending machines, warehouse & factory applications, heavy foodservice & institutional equipment, textile applications, tool boxes, etc.



WHEEL	SWIVEL #	WHEEL	WHEEL	WHEEL	WHEEL	REPLACE ** WITH FASTENER CODE		
						SWIVEL #	RIGID #	
3	1-13/16	DURAPLAS (POLYOLEFIN)	PLAIN	700	2-1/2	4-1/4	WC6630-**-XDP	WC6630R-**-XDP
		DURAPLAS (POLYOLEFIN)	ROLLER	700			WC6630-**-XDP-RB	WC6630R-**-XDP-RB
		HIGH TEMP GLASS FILLED NYLON	PLAIN	1000			WC6630-**-HTGFN	WC6630R-**-HTGFN
		HIGH TEMP GLASS FILLED NYLON	ROLLER	1000			WC6630-**-HTGFN-RB	WC6630R-**-HTGFN-RB
		YOKE, 5/8 AXLE/NUT	-	1000			WC6630-**-YAN	WC6630R-**-YAN
3-1/4	2	PHENOLIC YOKE ONLY	ROLLER -	700 700	4-1/4	4-1/4	WC6632-01-PHN WC6632-01-Y	WC6632R-01-PHN WC6632R-01-Y
4	2	DURAPLAS (POLYOLEFIN)	ROLLER	700	3-9/16	5-5/8	WC6640-**-XDP	WC6640R-**-XDP
		THERMAL PLASTIC RUBBER	ROLLER	300			WC6640-**-TPR	WC6640R-**-TPR
		PHENOLIC	ROLLER	800			WC6640-**-PHN	WC6640R-**-PHN
		POLYURETHANE ON CAST IRON	ROLLER	800			WC6640-**-PCI	WC6640R-**-PCI
		POLYURETHANE ON ALUMINUM	ROLLER	800			WC6640-**-PAL	WC6640R-**-PAL
		POLY-U ON POLY-O (BLUE ON BLACK)	ROLLER	800			WC6640-**-XLB	WC6640R-**-XLB
		RUBBER ON CAST IRON	ROLLER	350			WC6640-**-RCI	WC6640R-**-RCI
		ROUND THERMAL PLASTIC RUBBER	ROLLER	300			WC6640-**-RTP	WC6640R-**-RTP
		STEEL (CAST IRON)	ROLLER	900			WC6640-**-STL	WC6640R-**-STL
		V-GROOVE (CAST IRON)	ROLLER	900			WC6640-**-VG	WC6640R-**-VG
		SOLID POLYURETHANE	ROLLER	800			WC6640-**-SPU	WC6640R-**-SPU
		SOLID POLYURETHANE	6203 P.BB	800			WC6640-**-SPUP	WC6640R-**-SPUP
		YOKE ONLY	-	900			WC6640-**-Y	WC6640R-**-Y
YOKE NOTCHED W/ WELDED ON PSL	-	900	WC6640-**-Y-PSL	N/A				
5	2	DURAPLAS/POLY-O	ROLLER	900	4-1/4	6-1/2	WC6650-**-XDP	WC6650R-**-XDP
		THERMAL PLASTIC RUBBER	ROLLER	350			WC6650-**-TPR	WC6650R-**-TPR
		PHENOLIC	ROLLER	900			WC6650-**-PHN	WC6650R-**-PHN
		POLYURETHANE ON CAST IRON	ROLLER	900			WC6650-**-PCI	WC6650R-**-PCI
		POLYURETHANE ON ALUMINUM	ROLLER	900			WC6650-**-PAL	WC6650R-**-PAL
		POLY-U ON POLY-O (BLUE ON BLACK)	ROLLER	900			WC6650-**-XLB	WC6650R-**-XLB
		RUBBER ON CAST IRON	ROLLER	450			WC6650-**-RCI	WC6650R-**-RCI
		ROUND THERMAL PLASTIC RUBBER	ROLLER	350			WC6650-**-RTP	WC6650R-**-RTP
		STEEL (CAST IRON)	ROLLER	900			WC6650-**-STL	WC6650R-**-STL
		V-GROOVE (CAST IRON)	ROLLER	900			WC6650-**-VG	WC6650R-**-VG
		SOLID POLYURETHANE	ROLLER	900			WC6650-**-SPU	WC6650R-**-SPU
		SOLID POLYURETHANE	6203 P.BB	900			WC6650-**-SPUP	WC6650R-**-SPUP
		YOKE ONLY	-	900			WC6650-**-Y	WC6650R-**-Y
YOKE NOTCHED W/ WELDED ON PSL	-	900	WC6650-**-Y-PSL	N/A				
6	2	BALLOON CUSHION ON ALUMINUM	BALL	400	4-1/2	7-1/2	WC6660-**-GRND	WC6660R-**-GRND
		POLYOLEFIN	PLAIN	700			WC6660-**-HDP-PB	WC6660R-**-HDP-PB
		DURAPLAS/POLY-O	6203 P.BB	900			WC6660-**-XDPP	WC6660R-**-XDPP
		DURAPLAS/POLY-O	OILITE	900			WC6660-**-XDPO	WC6660R-**-XDPO
		DURAPLAS/POLY-O	PLAIN	900			WC6660-**-XDP-PB	WC6660R-**-XDP-PB
		DURAPLAS/POLY-O	ROLLER	900			WC6660-**-XDP	WC6660R-**-XDP
		THERMAL PLASTIC RUBBER	ROLLER	410			WC6660-**-TPR	WC6660R-**-TPR
		PHENOLIC	ROLLER	900			WC6660-**-PHN	WC6660R-**-PHN
		POLYURETHANE ON CAST IRON	ROLLER	900			WC6660-**-PCI	WC6660R-**-PCI
		POLYURETHANE ON ALUMINUM	ROLLER	900			WC6660-**-PAL	WC6660R-**-PAL
		POLY-U ON POLY-O (BLUE ON BLACK)	ROLLER	900			WC6660-**-XLB	WC6660R-**-XLB
		RUBBER ON CAST IRON	ROLLER	500			WC6660-**-RCI	WC6660R-**-RCI
		ROUND THERMAL PLASTIC RUBBER	ROLLER	410			WC6660-**-RTP	WC6660R-**-RTP
		STEEL (CAST IRON)	ROLLER	900			WC6660-**-STL	WC6660R-**-STL
		V-GROOVE (CAST IRON)	ROLLER	900			WC6660-**-VG	WC6660R-**-VG
		SOLID POLYURETHANE	ROLLER	900			WC6660-**-SPU	WC6660R-**-SPU
		SOLID POLYURETHANE	6203 P.BB	900			WC6660-**-SPUP	WC6660R-**-SPUP
YOKE ONLY	-	900	WC6660-**-Y	WC6660R-**-Y				
YOKE NOTCHED W/ WELDED ON PSL	-	900	WC6660-**-Y-PSL	N/A				

NOTE: COMING LATE 2005 ALL 6600 SERIES SWIVELS WILL COME WITH PSL NOTCHES STANDARD.



WC 6600 SERIES

WHEEL	WHEEL	WHEEL	WHEEL	WHEEL	WHEEL	REPLACE ** WITH FASTENER CODE		
						SWIVEL #	RIGID #	
8	2	BALLOON CUSHION ON ALUMINUM	BALL	450	6-1/2	9-1/2	WC6680-**-GRND	WC6680R-**-GRND
		POLY-U/POLY-O (GRAY)	ROLLER	900			WC6680-**-XLG	WC6680R-**-XLG
		POLY-U/POLY-O (BLUE)	ROLLER	900			WC6680-**-XLB	WC6680R-**-XLB
		DURAPLAS/POLY-O	ROLLER	900			WC6680-**-XDP	WC6680R-**-XDP
		THERMAL PLASTIC RUBBER	ROLLER	500			WC6680-**-TPR	WC6680R-**-TPR
		PHENOLIC	ROLLER	900			WC6680-**-PHN	WC6680R-**-PHN
		POLY-U/CAST IRON	ROLLER	900			WC6680-**-PCI	WC6680R-**-PCI
		POLY-U/ALUMINUM	ROLLER	900			WC6680-**-PAL	WC6680R-**-PAL
		RUBBER/CAST IRON	ROLLER	600			WC6680-**-RCI	WC6680R-**-RCI
		ROUND THERMAL PLASTIC RUBBER	ROLLER	500			WC6680-**-RTP	WC6680R-**-RTP
		STEEL	ROLLER	900			WC6680-**-STL	WC6680R-**-STL
		V-GROOVE	ROLLER	900			WC6680-**-VG	WC6680R-**-VG
		SOLID POLY-U	ROLLER	900			WC6680-**-SPU	WC6680R-**-SPU
		SOLID POLY-U	6203-P.BB	900			WC6680-**-SPUP	WC6680R-**-SPUP
		YOKE ONLY	-	900			WC6680-**-Y	WC6680R-**-Y
		YOKE NOTCHED W/ WELDED ON PSL	-	900			WC6680-**-Y-PSL	N/A

FASTENERS FOR WC 6600 SERIES		
FASTENER TYPE	CODE	SIZE
TOP PLATE	01	OVERALL SIZE: 4 x 4-1/2 BOLT HOLE PATTERN: 2-5/8 x 3-5/8 SLOTTED TO 3 x 3 ATTACHING BOLT SIZE: 3/8
TOP PLATE	02	OVERALL SIZE: 4-1/2 x 6-1/4 BOLT HOLE PATTERN: 2-7/16 x 4-15/16 SLOTTED TO 3-3/8 x 5-1/4 ATTACHING BOLT SIZE: 3/8
TOP PLATE	04	OVERALL SIZE: 5 x 5-1/2 BOLT HOLE PATTERN: 4-1/8 x 4-1/2 ATTACHING BOLT SIZE: 7/16
THREADED STEM	21	A-B x C 3/4-10 x 1-31/32
	22	3/4-10 x 1-3/4
	24	5/8-11 x 1-3/4 (STANDARD ON 3" [6630])
	25	1/2-13 x 1-3/4 (STANDARD ON 3" [6630])
	31	1-3/8 x 4 WITH 1/2 CROSS DRILLED HOLE 2-1/2" UP CENTERED
PLAIN ROUND	31	

BEARING OPTIONS:	
(Add the desired bearing option abbreviation after the wheel designator). Example: WC6660-01-XDP-BB	
DELIN BEARINGS 3/4" I.D. W/ STEEL SPANNER TO 1/2"	DBO
DELIN BEARINGS 3/4" I.D. W/ DELIN SPANNER TO 1/2"	DBD
DELIN BEARINGS 1/2" I.D.	DB
ROLLER BEARINGS WITH ALL METAL COMPONENTS (A must for high-temp applications)	AMC
SEALED PRECISION BALL BEARINGS (See bearing explanation & picture on the bottom of the page)	BB

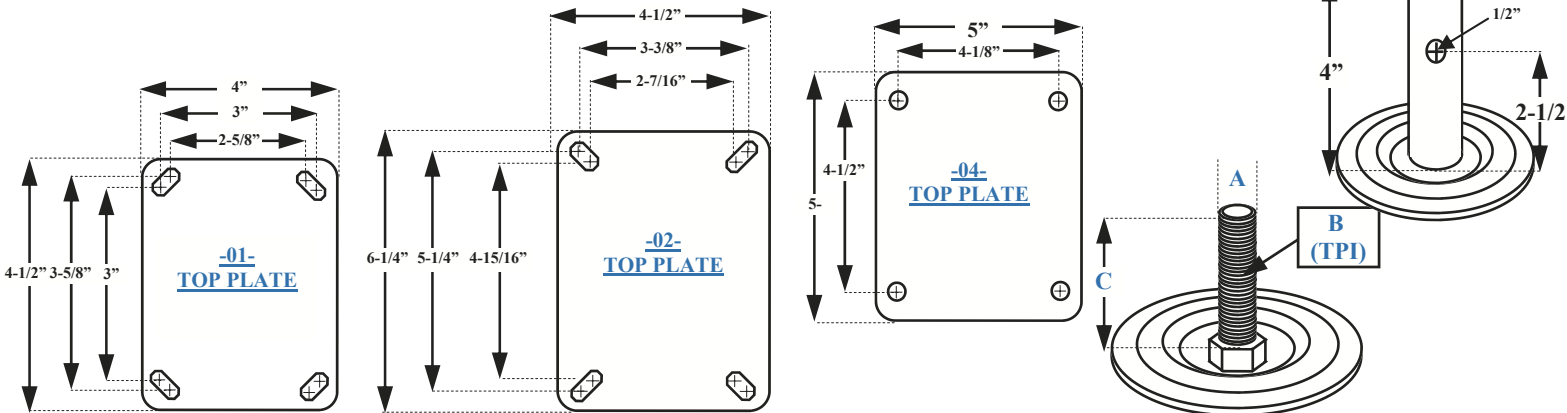

OPTIONS FOR WC 6600 SERIES (Add option abbreviation to end of the caster part #)

INTEGRATED TLB	INTEGRATED TLB WORKS ON RIGIDS!	POSITION LOCK	THREAD GAURDS	THUMB SCREW BRAKE	RACEWAY SEALS	QUICK CHANGE PLATE "TOOL-LESS"	SPECIAL FINISHES (FACTORY ORDER)
TLB	TLB	PSL	TG	TSB	SL	WCQCP-01-6600 (ZINC, BOLT-ON TYPE)	
						WCQCP-01-6600-UNPLATED (WELD-ON)	

SPECIAL FINISHES (FACTORY ORDER)	
POLISHED	PGF
GOLD FINISH	
BLACK OXIDE	BO
NICKLE	N
CHROME	CR



WC S6600 SERIES



- Polished 304 STAINLESS STEEL provides an attractive appearance.
- Highly resistant to conditions that would normally corrode and rust regular steel casters.
- Seals in both the upper and lower raceways standard. Seals must be removed for high-temp applications over 160 degrees Fahrenheit!
- Double ball raceways provide extra capacity & durability
- 5/8" nut and bolt kingpin.
- Applications: Ideal for wet, damp conditions or other corrosive environments such as wash downs, restaurants, food processing plants, hospitals & other institutional applications, etc.

WHEEL	Yoke	WHEEL	Roller	Nut	Bolt	REPLACE ** WITH FASTENER CODE		
						SWIVEL #	RIGID #	
3	1-13/16	DURAPLAS (POLYOLEFIN) HIGH TEMP GLASS FILLED NYLON YOKE, 5/8" AXLE & NUT	PLAIN PLAIN -	700 900 900	2-1/2	4-1/4	WCS6630-**-XDP WCS6630-**-HTGFN WCS6630-**-YAN	WCS6630R-**-XDP WCS6630R-**-HTGFN WCS6630R-**-YAN
4	2	THERMAL PLASTIC RUBBER THERMAL PLASTIC RUBBER DURAPLAS (POLYOLEFIN) DURAPLAS (POLYOLEFIN) POLY-U / POLY-O (BLUE ON BLACK) POLY-U / POLY-O (BLUE ON BLACK) ROUND THERMAL PLASTIC RUBBER ROUND THERMAL PLASTIC RUBBER SOLID POLYURETHANE SOLID POLYURETHANE POLYURETHANE ON ALUMINUM POLYURETHANE ON ALUMINUM YOKE ONLY YOKE NOTCHED W/ WELDED ON PSL	DELTRIN B/S SS ROLLER DELTRIN B/S SS ROLLER DELTRIN B/S SS ROLLER DELTRIN B/S SS ROLLER DELTRIN B/S SS ROLLER DELTRIN B/S SS ROLLER DELTRIN B/S SS ROLLER -	300 300 700 700 800 800 300 300 800 800 800 800 800 800 900 900	3-9/16	5-5/8	WCS6640-**-TPR-DBD WCS6640-**-TPR WCS6640-**-XDP-DBD WCS6640-**-XDP WCS6640-**-XLB-DBD WCS6640-**-XLB WCS6640-**-RTP-DBD WCS6640-**-RTP WCS6640-**-SPU-DBD WCS6640-**-SPU WCS6640-**-PAL-DBD WCS6640-**-PAL WCS6640-**-Y WCS6640-**-Y-PSL	WCS6640R-**-TPR-DBD WCS6640R-**-TPR WCS6640R-**-XDP-DBD WCS6640R-**-XDP WCS6640R-**-XLB-DBD WCS6640R-**-XLB WCS6640R-**-RTP-DBD WCS6640R-**-RTP WCS6640R-**-SPU-DBD WCS6640R-**-SPU WCS6640R-**-PAL-DBD WCS6640R-**-PAL WCS6640R-**-Y WCS6640R-**-Y-PSL
5	2	DURAPLAS (POLYOLEFIN) DURAPLAS (POLYOLEFIN) THERMAL PLASTIC RUBBER THERMAL PLASTIC RUBBER POLY-U / POLY-O (BLUE ON BLACK) POLY-U / POLY-O (BLUE ON BLACK) ROUND THERMAL PLASTIC RUBBER ROUND THERMAL PLASTIC RUBBER SOLID POLYURETHANE SOLID POLYURETHANE POLYURETHANE ON ALUMINUM POLYURETHANE ON ALUMINUM YOKE ONLY YOKE NOTCHED W/ WELDED ON PSL	DELTRIN B/S SS ROLLER DELTRIN B/S SS ROLLER DELTRIN B/S SS ROLLER DELTRIN B/S SS ROLLER DELTRIN B/S SS ROLLER DELTRIN B/S SS ROLLER -	900 900 350 350 900 900 350 350 900 900 900 900 900 900	4-1/4	6-1/2	WCS6650-**-XDP-DBD WCS6650-**-XDP WCS6650-**-TPR-DBD WCS6650-**-TPR WCS6650-**-XLB-DBD WCS6650-**-XLB WCS6650-**-RTP-DBD WCS6650-**-RTP WCS6650-**-SPU-DBD WCS6650-**-SPU WCS6650-**-PAL-DBD WCS6650-**-PAL WCS6650-**-Y WCS6650-**-Y-PSL	WCS6650R-**-XDP-DBD WCS6650R-**-XDP WCS6650R-**-TPR-DBD WCS6650R-**-TPR WCS6650R-**-XLB-DBD WCS6650R-**-XLB WCS6650R-**-RTP-DBD WCS6650R-**-RTP WCS6650R-**-SPU-DBD WCS6650R-**-SPU WCS6650R-**-PAL-DBD WCS6650R-**-PAL WCS6650R-**-Y WCS6650R-**-Y-PSL
6	2	DURAPLAS (POLYOLEFIN) DURAPLAS (POLYOLEFIN) DURAPLAS (POLYOLEFIN) DURAPLAS (POLYOLEFIN) THERMAL PLASTIC RUBBER THERMAL PLASTIC RUBBER POLY-U / POLY-O (BLUE ON BLACK) POLY-U / POLY-O (BLUE ON BLACK) ROUND THERMAL PLASTIC RUBBER ROUND THERMAL PLASTIC RUBBER SOLID POLYURETHANE SOLID POLYURETHANE STRAIGHT SIDED SOLID POLY-U STRAIGHT SIDED SOLID POLY-U POLYURETHANE ON ALUMINUM POLYURETHANE ON ALUMINUM POLYOLEFIN YOKE ONLY YOKE NOTCHED W/ WELDED ON PSL	DELTRIN B/S PLAIN SS SPANNER SS ROLLER DELTRIN B/S SS ROLLER DELTRIN B/S SS ROLLER DELTRIN B/S SS ROLLER DELTRIN B/S SS ROLLER DELTRIN B/S SS ROLLER DELTRIN B/S SS ROLLER PLAIN -	900 900 900 900 410 410 900 900 410 410 900 900 900 900 900 900 900 900	4-1/2	7-1/2	WCS6660-**-XDP-DBD WCS6660-**-XDP-PB WCS6660-**-XDPO WCS6660-**-XDP WCS6660-**-TPR-DBD WCS6660-**-TPR WCS6660-**-XLB-DBD WCS6660-**-XLB WCS6660-**-RTP-DBD WCS6660-**-RTP WCS6660-**-SPU-DBD WCS6660-**-SPU WCS6660-**-SSPU-DBD WCS6660-**-SSPU WCS6660-**-PAL-DBD WCS6660-**-PAL WCS6660-**-HDP-PB WCS6660-**-Y WCS6660-**-Y-PSL	WCS6660R-**-XDP-DBD WCS6660R-**-XDP-PB WCS6660R-**-XDPO WCS6660R-**-XDP WCS6660R-**-TPR-DBD WCS6660R-**-TPR WCS6660R-**-XLB-DBD WCS6660R-**-XLB WCS6660R-**-RTP-DBD WCS6660R-**-RTP WCS6660R-**-SPU-DBD WCS6660R-**-SPU WCS6660R-**-SSPU-DBD WCS6660R-**-SSPU WCS6660R-**-PAL-DBD WCS6660R-**-PAL WCS6660R-**-HDP-PB WCS6660R-**-Y WCS6660R-**-Y-PSL



WC S6600 SERIES

WHEEL	WHEEL	WHEEL	WHEEL	WHEEL	WHEEL	REPLACE ** WITH FASTENER CODE		
						SWIVEL #	RIGID #	
8	2	DURAPLAS (POLYOLEFIN)	DELTRIN B/S	900	6-1/2	9-1/2	WCS6680-**-XDP-DBD	WCS6680R-**-XDP-DBD
		DURAPLAS (POLYOLEFIN)	SS ROLLER	900			WCS6680-**-XDP	WCS6680R-**-XDP
		THERMAL PLASTIC RUBBER	DELTRIN B/S	450			WCS6680-**-TPR-DBD	WCS6680R-**-TPR-DBD
		THERMAL PLASTIC RUBBER	SS ROLLER	450			WCS6680-**-TPR	WCS6680R-**-TPR
		POLY-U / POLY-O (BLUE ON BLACK)	DELTRIN B/S	900			WCS6680-**-XLB-DBD	WCS6680R-**-XLB-DBD
		POLY-U / POLY-O (BLUE ON BLACK)	SS ROLLER	900			WCS6680-**-XLB	WCS6680R-**-XLB
		POLY-U / POLY-O (GRAY ON BEIGE)	DELTRIN B/S	900			WCS6680-**-XLG-DBD	WCS6680R-**-XLG-DBD
		POLY-U / POLY-O (GRAY ON BEIGE)	SS ROLLER	900			WCS6680-**-XLG	WCS6680R-**-XLG
		ROUND THERMAL PLASTIC RUBBER	DELTRIN B/S	450			WCS6680-**-RTP-DBD	WCS6680R-**-RTP-DBD
		ROUND THERMAL PLASTIC RUBBER	SS ROLLER	450			WCS6680-**-RTP	WCS6680R-**-RTP
		SOLID POLYURETHANE	DELTRIN B/S	900			WCS6680-**-SPU-DBD	WCS6680R-**-SPU-DBD
		SOLID POLYURETHANE	SS ROLLER	900			WCS6680-**-SPU	WCS6680R-**-SPU
		POLYURETHANE ON ALUMINUM	DELTRIN B/S	900			WCS6680-**-PAL-DBD	WCS6680R-**-PAL-DBD
		POLYURETHANE ON ALUMINUM	SS ROLLER	900			WCS6680-**-PAL	WCS6680R-**-PAL
		YOKE ONLY	-	900			WCS6680-**-Y	WCS6680R-**-Y
		YOKE NOTCHED W/ WELDED ON PSL	-	900			WCS6680-**-Y-PSL	WCS6680R-**-Y-PSL



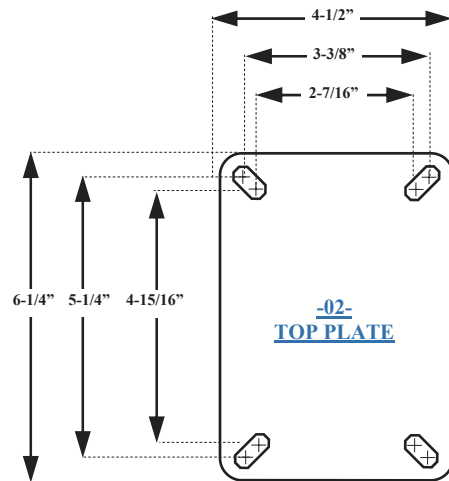
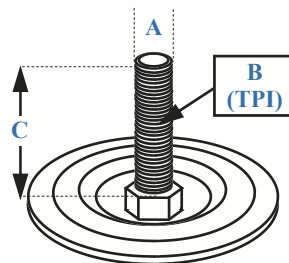
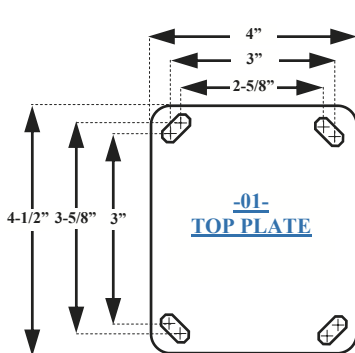

FASTENERS FOR WC S6600 SERIES		
TYPE	CODE	SIZE
TOP PLATE	01	OVERALL SIZE: 4 x 4-1/2
		BOLT HOLE PATTERN: 2-5/8 x 3-5/8 SLOTTED TO 3 x 3 ATTACHING BOLT SIZE: 3/8
TOP PLATE	02	OVERALL SIZE: 4-1/2 x 6-1/4
		BOLT HOLE SPACING: 2-7/16 x 4-15/16 SLOTTED TO 3-3/8 x 5-1/4 ATTACHING BOLT SIZE: 1/2
THREADED STEM	21	A-B x C
	22	3/4-10 x 1-31/32
	24	3/4-10 x 1-3/4
	25	5/8-11 x 1-3/4
	25	1/2-13 x 1-3/4

BEARING OPTIONS:	
(Add the desired bearing option abbreviation after the wheel designator). Example: WCS6660-01-XDP-BB	
DELTRIN BEARINGS 3/4" I.D. W/ STAINLESS STEEL SPANNER TO 1/2"	DBS
DELTRIN BEARINGS 3/4" I.D. W/ DELTRIN SPANNER TO 1/2"	DBD
DELTRIN BEARINGS 1/2" I.D.	DB
ROLLER BEARINGS WITH ALL STAINLESS STEEL COMPONENTS	ASC
STAINLESS STEEL SEALED PRECISION BALL BEARINGS (See bearing explanation & picture on the bottom of the page)	SBB



OPTIONS FOR WC S6600 SERIES

(Add option abbreviation to end of the caster part #)

 <p>INTEGRATED TLB</p> <p>TLB</p>	 <p>INTEGRATED TLB WORKS ON RIGIDS!</p> <p>TLB</p>	 <p>POLY CAP FOR BRAKE ARM</p> <p>TLBP</p>	 <p>POSITION LOCK</p> <p>PSL</p>	 <p>RACEWAY SEAL & ZERK FITTING (COMES STANDARD)</p>	<p>WC S6600 SERIES CASTERS AVAILABLE WITHOUT SEALS FOR HIGH-TEMP APPLICATIONS. ADD -WOS TO THE END OF THE PART # (EXAMPLE: WCS6660-01-Y-WOS)</p>
--	---	---	---	---	--

Use Stainless Steel Sealed Precision Ball Bearings in any wheel instead of Roller Bearings!

Sealed precision ball bearings provide a low maintenance, ergonomic ride with minimal effort to start-up and push loads. To order, change the part number as follows: Add a -SBB, after the wheel designation.
(Example: Standard roller bearing caster, WCS6680-01-XLG. Caster with Sealed precision bearings, WCS6680-01-XLG-SBB).

WC 6800 SERIES



- Case hardened double ball raceways provide extra capacity & durability
- Top plate and legs are made out of 1/4" cold forged steel. Machine-welded legs for uniform consistency and strength.
- Corrosion-resistant zinc plated finish.
- 3/4" Nut and bolt kingpin, 2-1/2" & new 3" fork spacings.
- Zerk grease fittings in axle, swivel bearings and most wheels.
- New optional fork spacing enables us to provide a more economical 2-1/2" face wheel caster.
- Applications: Platform trucks, freight terminal trucks, cargo containers, drying racks, ground support equipment, mobile military equipment, A frames, etc.

		WHEEL				SWIVEL #	RIGID #	
4	2	THERMAL PLASTIC RUBBER	ROLLER	300	3-13/16	5-5/8	WC6840-01-TPR	WC6840R-01-TPR
		PHENOLIC	ROLLER	800			WC6840-01-PHN	WC6840R-01-PHN
		DURAPLAS (POLYOLEFIN)	ROLLER	700			WC6840-01-XDP	WC6840R-01-XDP
		POLYURETHANE ON CAST IRON	ROLLER	800			WC6840-01-PCI	WC6840R-01-PCI
		POLYURETHANE ON ALUMINUM	ROLLER	800			WC6840-01-PAL	WC6840R-01-PAL
		POLYURETHANE ON POLYOLEFIN	ROLLER	800			WC6840-01-XLB	WC6840R-01-XLB
		RUBBER ON CAST IRON	ROLLER	350			WC6840-01-RCI	WC6840R-01-RCI
		ROUND THERMAL PLASTIC RUBBER	ROLLER	300			WC6840-01-RTP	WC6840R-01-RTP
		SOLID POLYURETHANE	ROLLER	800			WC6840-01-SPU	WC6840R-01-SPU
		SOLID POLYURETHANE	6203 P.BB	900			WC6840-01-SPUP	WC6840R-01-SPUP
		DUCTILE STEEL	ROLLER	1400			WC6840-01-DUC	WC6840R-01-DUC
		STEEL (CAST IRON)	ROLLER	1000			WC6840-01-STL	WC6840R-01-STL
		V-GROOVE (CAST IRON)	ROLLER	1000			WC6840-01-VG	WC6840R-01-VG
		YOKE ONLY	-	1400			WC6840-01-Y	WC6840R-01-Y
5	2	DURAPLAS (POLYOLEFIN)	ROLLER	1000	4-1/4	6-1/2	WC6850-01-XDP	WC6850R-01-XDP
		THERMAL PLASTIC RUBBER	ROLLER	350			WC6850-01-TPR	WC6850R-01-TPR
		PHENOLIC	ROLLER	1000			WC6850-01-PHN	WC6850R-01-PHN
		POLYURETHANE ON CAST IRON	ROLLER	1100			WC6850-01-PCI	WC6850R-01-PCI
		POLYURETHANE ON ALUMINUM	ROLLER	1100			WC6850-01-PAL	WC6850R-01-PAL
		POLYURETHANE ON POLYOLEFIN	ROLLER	900			WC6850-01-XLB	WC6850R-01-XLB
		RUBBER ON CAST IRON	ROLLER	450			WC6850-01-RCI	WC6850R-01-RCI
		ROUND THERMAL PLASTIC RUBBER	ROLLER	350			WC6850-01-RTP	WC6850R-01-RTP
		SOLID POLYURETHANE	ROLLER	1000			WC6850-01-SPU	WC6850R-01-SPU
		SOLID POLYURETHANE	6203 P.BB	1200			WC6850-01-SPUP	WC6850R-01-SPUP
		DUCTILE STEEL	ROLLER	1400			WC6850-01-DUC	WC6850R-01-DUC
		STEEL (CAST IRON)	ROLLER	1100			WC6850-01-STL	WC6850R-01-STL
		V-GROOVE (CAST IRON)	ROLLER	1100			WC6850-01-VG	WC6850R-01-VG
		YOKE ONLY	-	1400			WC6850-01-Y	WC6850R-01-Y
6	2	DURAPLAS (POLYOLEFIN)	ROLLER	1200	4-1/2	7-1/2	WC6860-01-XDP	WC6860R-01-XDP
		DURAPLAS (POLYOLEFIN)	PLAIN	1200			WC6860-01-XDP-PB	WC6860R-01-XDP-PB
		DURAPLAS (POLYOLEFIN)	OILITE	1200			WC6860-01-XDPO	WC6860R-01-XDPO
		DURAPLAS (POLYOLEFIN)	6203 P.BB	1300			WC6860-01-XDPP	WC6860R-01-XDPP
		BALLOON CUSHION	BALL	350			WC6860-01-GRND	WC6860R-01-GRND
		THERMAL PLASTIC RUBBER	ROLLER	410			WC6860-01-TPR	WC6860R-01-TPR
		PHENOLIC	ROLLER	1200			WC6860-01-PHN	WC6860R-01-PHN
		POLYURETHANE ON CAST IRON	ROLLER	1250			WC6860-01-PCI	WC6860R-01-PCI
		POLYURETHANE ON ALUMINUM	ROLLER	1250			WC6860-01-PAL	WC6860R-01-PAL
		POLYURETHANE ON POLYOLEFIN	ROLLER	1000			WC6860-01-XLB	WC6860R-01-XLB
		RUBBER ON CAST IRON	ROLLER	500			WC6860-01-RCI	WC6860R-01-RCI
		ROUND THERMAL PLASTIC RUBBER	ROLLER	410			WC6860-01-RTP	WC6860R-01-RTP
		SOLID POLYURETHANE	ROLLER	1200			WC6860-01-SPU	WC6860R-01-SPU
		SOLID POLYURETHANE	6203 P.BB	1400			WC6860-01-SPUP	WC6860R-01-SPUP
		SS SOLID POLY-U	ROLLER	1400			WC6860-01-SSPU	WC6860R-01-SSPU
		DUCTILE STEEL	ROLLER	1400			WC6860-01-DUC	WC6860R-01-DUC
		STEEL (CAST IRON)	ROLLER	1400			WC6860-01-STL	WC6860R-01-STL
		V-GROOVE (CAST IRON)	ROLLER	1400			WC6860-01-VG	WC6860R-01-VG
		POLYOLEFIN	PLAIN	700			WC6860-01-HDP-PB	WC6860R-01-HDP-PB
YOKE ONLY	-	1400	WC6860-01-Y	WC6860R-01-Y				

WC 6800 SERIES

		WHEEL				SWIVEL #	RIGID #	
6	2-1/2	RUBBER ON CAST IRON POLYURETHANE ON CAST IRON PHENOLIC STEEL (CAST IRON) YOKE ONLY	ROLLER -	700 1500 1500 1500 1500	4-1/2	7-1/2	*WC68625-01-RCI *WC68625-01-PCI *WC68625-01-PHN *WC68625-01-STL *WC68625-01-YAN	*WC68625R-01-RCI *WC68625R-01-PCI *WC68625R-01-PHN *WC68625R-01-STL *WC68625R-01-YAN
8	2	DURAPLAS (POLYOLEFIN) BALLOON CUSHION THERMAL PLASTIC RUBBER PHENOLIC POLYURETHANE ON CAST IRON POLYURETHANE ON ALUMINUM POLY-U / POLY-O (GRAY ON BEIGE) POLY-U / POLY-O (BLUE ON BLACK) RUBBER ON CAST IRON ROUND THERMAL PLASTIC RUBBER SOLID POLYURETHANE SOLID POLYURETHANE DUCTILE STEEL STEEL (CAST IRON) V-GROOVE (CAST IRON) YOKE ONLY	ROLLER ROLLER ROLLER ROLLER ROLLER ROLLER ROLLER ROLLER ROLLER ROLLER 6203 P.BB ROLLER ROLLER ROLLER -	1400 450 500 1400 1400 1400 1100 1100 600 500 1300 1400 1400 1400 1400	6-1/2	9-1/2	WC6880-01-XDP WC6880-01-GRND WC6880-01-TPR WC6880-01-PHN WC6880-01-PCI WC6880-01-PAL WC6880-01-XLG WC6880-01-XLB WC6880-01-RCI WC6880-01-RTP WC6880-01-SPU WC6880-01-SPUP WC6880-01-DUC WC6880-01-STL WC6880-01-VG WC6880-01-Y	WC6880R-01-XDP WC6880R-01-GRND WC6880R-01-TPR WC6880R-01-PHN WC6880R-01-PCI WC6880R-01-PAL WC6880R-01-XLG WC6880R-01-XLB WC6880R-01-RCI WC6880R-01-RTP WC6880R-01-SPU WC6880R-01-SPUP WC6880R-01-DUC WC6880R-01-STL WC6880R-01-VG WC6880R-01-Y
8	2-1/2	RUBBER ON CAST IRON POLYURETHANE ON CAST IRON PHENOLIC STEEL (CAST IRON) YOKE	ROLLER -	850 1500 1500 1500	6-1/2	9-1/2	*WC68825-01-RCI *WC68825-01-PCI *WC68825-01-PHN *WC68825-01-STL *WC68825-01-YAN	*WC68825R-01-RCI *WC68825R-01-PCI *WC68825R-01-PHN *WC68825R-01-STL *WC68825R-01-YAN

* These casters come standard with double welded fork legs & 1/2" axle.

FASTENERS FOR WC 6800 SERIES			
FASTENER TYPE	CODE	SIZE	
TOP PLATE	01	OVERALL SIZE:	4-1/2 x 6-1/4
		BOLT HOLE SPACING:	2-7/16 x 4-15/16 SLOTTED TO 3-3/8 x 5-1/4
		ATTACHING BOLT SIZE:	1/2

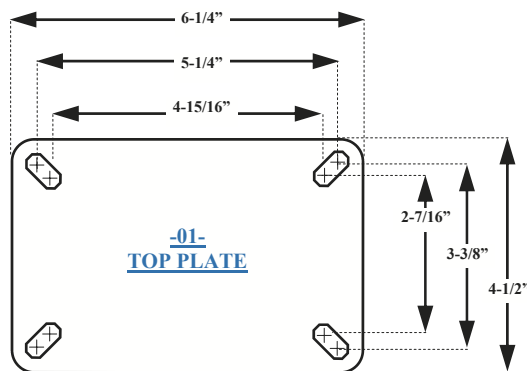

BEARING OPTIONS:	
(Add the desired bearing option abbreviation after the wheel designator). Example: WC6860-01-XDP-BB	
DELIN BEARINGS 3/4" I.D. W/ STEEL SPANNER TO 1/2"	DBO
DELIN BEARINGS 3/4" I.D. W/ DELIN SPANNER TO 1/2"	DBD
DELIN BEARINGS 1/2" I.D.	DB
ROLLER BEARINGS WITH ALL METAL COMPONENTS (A must for high-temp applications)	AMC
SEALED PRECISION BALL BEARINGS (See bearing explanation & picture on the bottom of the page)	BB

OPTIONS FOR WC 6800 SERIES

(Add option abbreviation to end of the caster part #)



SPECIAL FINISHES (FACTORY ORDER)	
POLISHED GOLD FINISH	PGF
BLACK OXIDE	BO
NICKLE	N
CHROME	CR

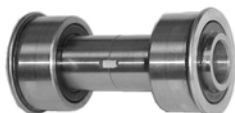

Use Sealed Precision Ball Bearings in any wheel instead of Roller Bearings!

Sealed precision ball bearings provide a low maintenance, ergonomic ride with minimal effort to start-up and push loads. To order, change the part number as follows: Add a -BB, after the wheel designation.
(Example: Standard roller bearing caster, WC6880-01-XLG. Caster with Sealed precision bearings, WC6880-01-XLG-BB).

WC 6900 SERIES



- **Economy Cold Forged Series** provides the mobility advantage of the larger diameter wheels at a very competitive price.
- 23/64" thick double-welded legs provide superior strength against side impact and abuse, extending the life of the casters.
- 3/4" nut-and-bolt king pin & axle.
- Case hardened double ball raceways provide extra capacity & durability
- 1/4" thick top plate.
- 3" fork spacing.
- Applications: Large platform trucks, freight terminal trucks, cargo containers, and drying racks.

		WHEEL					SWIVEL #	RIGID #
6	2-1/2	RUBBER ON CAST IRON POLYURETHANE ON CAST IRON PHENOLIC STEEL (CAST IRON) YOKE ONLY	ROLLER -	700 1600 1600 1600 1800	4-3/4	7-1/2	WC6960-01-RCI WC6960-01-PCI WC6960-01-PHN WC6960-01-STL WC6960-01-Y	WC6960R-01-RCI WC6960R-01-PCI WC6960R-01-PHN WC6960R-01-STL WC6960R-01-Y
8	2-1/2	RUBBER ON CAST IRON POLYURETHANE ON CAST IRON PHENOLIC STEEL (CAST IRON) YOKE	ROLLER -	850 1800 1800 1800	6-1/16	10-1/8	WC6980-01-RCI WC6980-01-PCI WC6980-01-PHN WC6980-01-STL WC6980-01-Y	WC6980R-01-RCI WC6980R-01-PCI WC6980R-01-PHN WC6980R-01-STL WC6980R-01-Y
10	2-1/2	RUBBER ON CAST IRON POLYURETHANE ON CAST IRON PHENOLIC STEEL (CAST IRON) YOKE ONLY	ROLLER -	950 1800 1800 1800	7-9/16	11-1/2	WC6910-01-RCI WC6910-01-PCI WC6910-01-PHN WC6910-01-STL WC6910-01-Y	WC6910R-01-RCI WC6910R-01-PCI WC6910R-01-PHN WC6910R-01-STL WC6910R-01-Y
12	2-1/2	RUBBER ON CAST IRON POLYURETHANE ON CAST IRON PHENOLIC STEEL (CAST IRON) YOKE ONLY	ROLLER -	950 1800 1800 1800	8-3/4	13-1/2	WC6912-01-RCI WC6912-01-PCI WC6912-01-PHN WC6912-01-STL WC6912-01-Y	WC6912R-01-RCI WC6912R-01-PCI WC6912R-01-PHN WC6912R-01-STL WC6912R-01-Y

FASTENER TYPE	CODE	SIZE
TOP PLATE	01	OVERALL SIZE: 4-1/2 x 6-1/4 BOLT HOLE SPACING: 2-7/16 x 4-15/16 SLOTTED TO 3-3/8 x 5-1/4 ATTACHING BOLT SIZE: 1/2

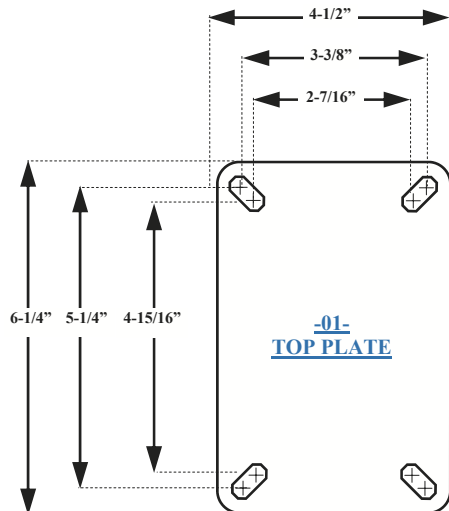

INTEGRATED TLB



TLB

SPECIAL FINISHES
(FACTORY ORDER)

POLISHED	PGF
GOLD FINISH	
BLACK OXIDE	BO
NICKLE	N
CHROME	CR



WC 7000 SERIES



- **Economy Cold Forged Series** provides the mobility advantage of the larger diameter wheels at a very competitive price.
- 23/64" thick double-welded legs provide superior strength against side impact and abuse, extending the life of the casters.
- 1" Grade 5 nut-and-bolt king pin & 3/4" axle.
- 23/64" thick top plate.
- Fully hardened double ball raceways provide extra capacity & durability
- 3-3/4" fork spacing.
- Applications: Large platform trucks & buggies, freight terminal trucks, cargo containers, drying racks, heavy mobile machinery & equipment, heavy-duty material handling carts, heavy duty warehouse and manufacturing plant applications, etc.

WHEEL	YOKES	WHEEL	ROLLER	AXLE	FORK SPACING	KING PIN	REPLACE ** WITH FASTENER CODE	
							SWIVEL #	RIGID #
6	3	RUBBER ON CAST IRON POLYURETHANE ON CAST IRON PHENOLIC STEEL (CAST IRON) YOKE ONLY	ROLLER	750 2000 2000 2000 2000	4-3/4	7-1/2	WC7060-**-RCI WC7060-**-PCI WC7060-**-PHN WC7060-**-STL WC7060-**-Y	WC7060R-**-RCI WC7060R-**-PCI WC7060R-**-PHN WC7060R-**-STL WC7060R-**-Y
8	3	RUBBER ON CAST IRON POLYURETHANE ON CAST IRON PHENOLIC STEEL (CAST IRON) YOKE	ROLLER	900 2000 2000 2000 2000	6-1/4	10-1/8	WC7080-**-RCI WC7080-**-PCI WC7080-**-PHN WC7080-**-STL WC7080-**-Y	WC7080R-**-RCI WC7080R-**-PCI WC7080R-**-PHN WC7080R-**-STL WC7080R-**-Y
10	3	RUBBER ON CAST IRON POLYURETHANE ON CAST IRON PHENOLIC STEEL (CAST IRON) YOKE ONLY	ROLLER	1000 2000 2000 2000 2000	7-9/16	11-7/8	WC7010-**-RCI WC7010-**-PCI WC7010-**-PHN WC7010-**-STL WC7010-**-Y	WC7010R-**-RCI WC7010R-**-PCI WC7010R-**-PHN WC7010R-**-STL WC7010R-**-Y
12	3	RUBBER ON CAST IRON POLYURETHANE ON CAST IRON PHENOLIC STEEL (CAST IRON) YOKE ONLY	ROLLER	1200 2000 2000 2000 2000	8-9/16	13-7/8	WC7012-**-RCI WC7012-**-PCI WC7012-**-PHN WC7012-**-STL WC7012-**-Y	WC7012R-**-RCI WC7012R-**-PCI WC7012R-**-PHN WC7012R-**-STL WC7012R-**-Y

FASTENERS FOR WC 7000 SERIES		
FASTENER TYPE	CODE	SIZE
TOP PLATE	01	OVERALL SIZE: 4-1/2 x 6-1/4 BOLT HOLE SPACING: 2-7/16 x 4-15/16 SLOTTED TO 3-3/8 x 5-1/4 ATTACHING BOLT SIZE: 1/2
TOP PLATE	02	OVERALL SIZE: 5-9/32 x 7-1/4 BOLT HOLE SPACING: 3-3/8 x 5-1/4 SLOTTED TO 4-1/8 x 6-1/8 ATTACHING BOLT SIZE: 1/2

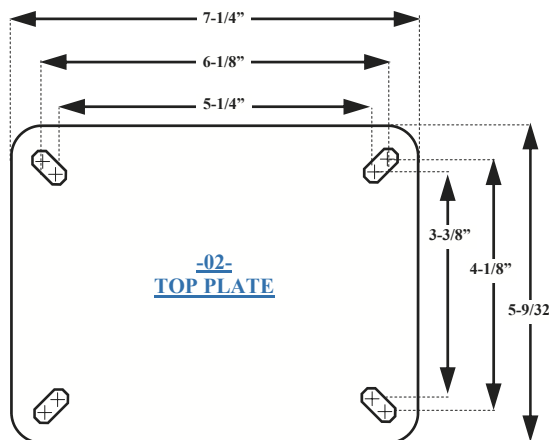
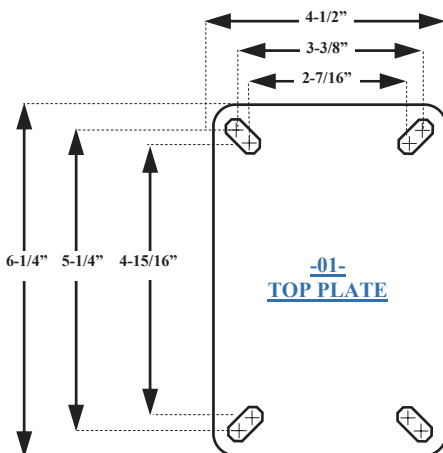

SPECIAL FINISHES (FACTORY ORDER)	
POLISHED	PGF
GOLD FINISH	
BLACK OXIDE	BO
NICKLE	N
CHROME	CR

WC 7600 SERIES



- For use in non-motorized applications only.
- Case hardened double ball raceways provide extra capacity & durability
- Zinc plated finish.
- Top plate & legs made from 1/4" steel.
- 2 piece bolt-together hub, inflatable tube in 4-PLY tire construction.
- Pneumatics tires available in both black & non-marking gray.
- New "Centipede" wheel is made out of microcellular Polyurethane foam. It provides a lightweight, cushioned ride without worry, maintenance or a flat tire. The hub assembly is a durable 2 piece nylon construction. These wheels perform best with precision ball bearings.
- Application: Carts, platform trucks for industrial, commercial and institutional environments demanding a cushioned ride. Carrying sensitive materials, chemicals, electronics, ceramics, glass, sound & lighting equipment. Great for the outdoors. (cement, dirt, gravel, grass, etc.)

WHEEL	WHEEL	WHEEL	WHEEL	WHEEL	WHEEL	REPLACE ** WITH FASTENER CODE		
						SWIVEL #	RIGID #	
6	2	PNEUMATIC SAWTOOTH TREAD	BALL	275	4-3/4	**7-3/8	WCP5660-01-B-BB (Black)	WCP5660R-01-B-BB (Black)
			ROLLER				WCP5660-01-G-BB (Gray)	WCP5660R-01-G-BB (Gray)
			BALL				WCP5660-01-B-RB (Black)	WCP5660R-01-B-RB (Black)
			ROLLER				WCP5660-01-G-RB (Gray)	WCP5660R-01-G-RB (Gray)
*8	2-1/2	(STANDARD SIZE) PNEUMATIC (280/250-4) SAWTOOTH TREAD *Actual diameter: 9"	BALL BEARING (STANDARD)	300	7-1/4	**10-1/8	WCP6660-01-B-BB (Black)	WCP6660R-01-B-BB (Black)
			PRECISION BALL				WCP6660-01-G-BB (Gray)	WCP6660R-01-G-BB (Gray)
			FLANGED ROLLER				WCP6660-01-B-RB (Black)	WCP6660R-01-B-RB (Black)
			STRAIGHT ROLLER				WCP6660-01-G-RB (Gray)	WCP6660R-01-G-RB (Gray)
*10	3	"CENTIPEDE WHEEL" Solid Microcellular Polyurethane Foam. NOT AIR FILLED.	BALL BEARING (ECONOMY)	250	8-1/2	**11-7/8	WCP7610-**-C (Black on Yellow)	WCP7610R-**-C (Black on Yellow)
			PRECISION BALL (STANDARD)				WCP7610-**-CG (Gray on Gray)	WCP7610R-**-CG (Gray on Gray)
							WCP7610-**-CKG (Black on Gray)	WCP7610R-**-CKG (Black on Gray)
							WCP7610-**-C-PB (Black on Yellow)	WCP7610R-**-C-PB (Black on Yellow)
*10	3-1/2	PNEUMATIC (410/350-4) SAWTOOTH TREAD *Actual diameter: 11-1/4"	BALL BEARING (STANDARD)	350	9-1/4	**12-1/16	WCP7610-**-B (Black)	WCP7610R-**-B (Black)
			PRECISION BALL				WCP7610-**-G (Gray)	WCP7610R-**-G (Gray)
			FLANGED ROLLER				WCP7610-**-B-PB (Black)	WCP7610R-**-B-PB (Black)
			STRAIGHT ROLLER				WCP7610-**-G-PB (Gray)	WCP7610R-**-G-PB (Gray)
*12	3-1/2	PNEUMATIC (410/350-6) SAWTOOTH TREAD *Actual diameter: 13.15"	BALL BEARING (STANDARD)	450	10-3/4	**14-1/4	WCP7610-**-B-FRB (Black)	WCP7610R-**-B-FRB (Black)
			PRECISION BALL				WCP7610-**-G-FRB (Gray)	WCP7610R-**-G-FRB (Gray)
			FLANGED ROLLER				WCP7610-**-B-RB (Black)	WCP7610R-**-B-RB (Black)
			STRAIGHT ROLLER				WCP7610-**-G-RB (Gray)	WCP7610R-**-G-RB (Gray)
*12	3-1/2	PNEUMATIC (410/350-6) SAWTOOTH TREAD *Actual diameter: 13.15"	BALL BEARING (STANDARD)	450	10-3/4	**14-1/4	WCP7612-**-B (Black)	WCP7612R-**-B (Black)
			PRECISION BALL				WCP7612-**-B-PB (Black)	WCP7612R-**-B-PB (Black)
			FLANGED ROLLER				WCP7612-**-G (Gray)	WCP7612R-**-G (Gray)
			STRAIGHT ROLLER				WCP7612-**-B-FRB (Black)	WCP7612R-**-B-FRB (Black)
							WCP7612-**-B-RB (Black)	WCP7612R-**-B-RB (Black)

** Overall height will vary depending on the load capacity applied.



WC 7600 SERIES

ECONOMY STAMPED YOKE, 6" FULL PNEUMATIC
#WCP5660-01-B-BB-TLB
 (SEE PICTURE ON PAGE 26)



NEW "CENTIPEDE" WHEEL.
NEVER GOES FLAT!

OTHER FASTENERS AVAILABLE
 FOR WC 5660,
 SEE WC 5600 SERIES ON PAGES 26 & 27.

CLASSY LOOK, PREMIUM RIDE!
 ALL METAL PARTS FINISHED IN A POLISHED
 GOLD/BRASS, GRAY NON-MARKING TIRES WITH
 SEALED PRECISION BALL BEARINGS,
 ADD: -PB-PGF TO THE PART #
 (EXAMPLE: WCP7690-01-G-PB-PGF-TLB)

FASTENERS FOR WC 7600 SERIES		
FASTENER TYPE	CODE	SIZE
(For WC 5660 only) TOP PLATE	(For WC 5660 only) 01	(For WC 5660 only) OVERALL SIZE: 2-1/2 x 3-3/4 BOLT HOLE PATTERN: 1-3/4 x 2-7/8 SLOTTED TO 3 ATTACHING BOLT SIZE: 5/16
(Standard plate) TOP PLATE	01 (-02- for WC 5660)	OVERALL SIZE: 4 x 4-1/2 BOLT HOLE SPACING: 2-5/8 x 3-5/8 SLOTTED TO 3 x 3 ATTACHING BOLT SIZE: 3/8
THREADED STEM	21 23 24	A-B x C 1/2-13 x 1-1/2 1/2-13 x 2-1/2 5/8-11 x 1-3/4

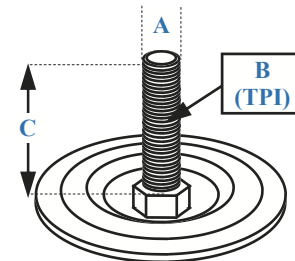
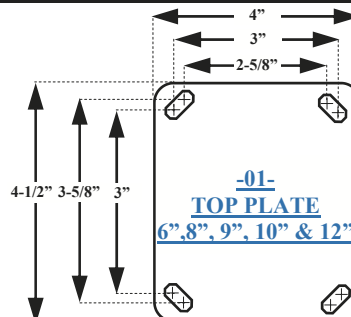
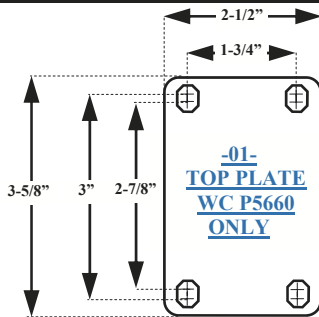

OPTIONS FOR WC 7600 SERIES (Add option abbreviation to end of the caster part #)

TOP LOCK
BRAKE



TLB

INTEGRATED TOP LOCK BRAKE
(FOR WC 5660, 6" & 6660 6" ONLY)



TLB

POSITION
LOCK



PSL

QUICK CHANGE PLATE "TOOL-LESS"



WCQCP-01-6600 (ZINC, BOLT-ON TYPE)
 WCQCP-01-6600-UNPLATED (WELD-ON)

SPECIAL FINISHES (FACTORY ORDER)

POLISHED GOLD BRASS FINISH	PGF
NICKLE	N
CHROME	CR
*POWDER COAT	PC

*PLEASE INQUIRE ABOUT
 COLOR OPTIONS.

WC 9000 SERIES



- One piece drop forged steel 1/4" top plate and inner raceway precision machined and hardened with 3/8 single ball bearing kingpinless style construction.
- Eliminates problems associated with kingpin failure.
- Legs are formed from 1/4" forged steel.
- 1/2 diameter axle bolt with lock nut. Zerk grease fitting in axle & raceway.
- Applications: Great for applications involving extreme shock loading, towing, moving over cracks, uneven floors, and tarmacs, heavy mobile machinery & equipment, heavy-duty material handling carts, buggies & platform trucks, ground support equipment, heavy duty warehouse and manufacturing plant applications, etc.

		WHEEL					SWIVEL #	RIGID #
4	2	DUCTILE STEEL	ROLLER	1500	3-3/8	5-11/16	WC9040-01-DUC	WC9040R-01-DUC
		LAMINATED PHENOLIC	ROLLER	1000			WC9040-01-LPN	WC9040R-01-LPN
		PHENOLIC	ROLLER	800			WC9040-01-PHN	WC9040R-01-PHN
		DURAPLAS (POLYOLEFIN)	ROLLER	700			WC9040-01-XDP	WC9040R-01-XDP
		POLYURETHANE ON CAST IRON	ROLLER	800			WC9040-01-PCI	WC9040R-01-PCI
		POLYURETHANE ON ALUMINUM	ROLLER	800			WC9040-01-PAL	WC9040R-01-PAL
		POLY-U/POLY-O (BLUE ON BLACK)	ROLLER	800			WC9040-01-XLB	WC9040R-01-XLB
		RUBBER ON CAST IRON	ROLLER	350			WC9040-01-RCI	WC9040R-01-RCI
		SOLID POLYURETHANE	ROLLER	800			WC9040-01-SPU	WC9040R-01-SPU
		SOLID POLYURETHANE	6203 P.BB	900			WC9040-01-SPUP	WC9040R-01-SPUP
		STEEL (CAST IRON)	ROLLER	1000			WC9040-01-STL	WC9040R-01-STL
		V-GROOVE (CAST IRON)	ROLLER	1000			WC9040-01-VG	WC9040R-01-VG
		YOKE ONLY	-	2000			WC9040-01-Y	WC9040R-01-Y
5	2	DUCTILE STEEL	ROLLER	1650	4-5/16	6-9/16	WC9050-01-DUC	WC9050R-01-DUC
		DURAPLAS (POLYOLEFIN)	ROLLER	1200			WC9050-01-XDP	WC9050R-01-XDP
		LAMINATED PHENOLIC	ROLLER	1250			WC9050-01-LPN	WC9050R-01-LPN
		PHENOLIC	ROLLER	1000			WC9050-01-PHN	WC9050R-01-PHN
		POLYURETHANE ON CAST IRON	ROLLER	1200			WC9050-01-PCI	WC9050R-01-PCI
		POLYURETHANE ON ALUMINUM	ROLLER	1200			WC9050-01-PAL	WC9050R-01-PAL
		POLY-U/POLY-O (BLUE ON BLACK)	ROLLER	900			WC9050-01-XLB	WC9050R-01-XLB
		RUBBER ON CAST IRON	ROLLER	450			WC9050-01-RCI	WC9050R-01-RCI
		SOLID POLYURETHANE	ROLLER	1000			WC9050-01-SPU	WC9050R-01-SPU
		SOLID POLYURETHANE	6203 P.BB	1200			WC9050-01-SPUP	WC9050R-01-SPUP
		STEEL (CAST IRON)	ROLLER	1000			WC9050-01-STL	WC9050R-01-STL
		V-GROOVE (CAST IRON)	ROLLER	1100			WC9050-01-VG	WC9050R-01-VG
		YOKE ONLY	-	2000			WC9050-01-Y	WC9050R-01-Y
6	2	EXTREME POLYURETHANE / STEEL	TAPERED	1600	5-1/4	7-1/2	WC9060-01-EPS-T	WC9060R-01-EPS-T
		BALLOON CUSHION ON ALUMINUM	BALL	400			WC9060-01-GRND	WC9060R-01-GRND
		POLYOLEFIN	PLAIN	700			WC9060-01-HDP-PB	WC9060R-01-HDP-PB
		DURAPLAS (POLYOLEFIN)	6203 P.BB	1300			WC9060-01-XDPP	WC9060R-01-XDPP
		DURAPLAS (POLYOLEFIN)	OILITE	1200			WC9060-01-XDPO	WC9060R-01-XDPO
		DURAPLAS (POLYOLEFIN)	PLAIN	1200			WC9060-01-XDP-PB	WC9060R-01-XDP-PB
		DURAPLAS (POLYOLEFIN)	ROLLER	1200			WC9060-01-XDP	WC9060R-01-XDP
		THERMAL PLASTIC RUBBER	ROLLER	410			WC9060-01-TPR	WC9060R-01-TPR
		PHENOLIC	ROLLER	1200			WC9060-01-PHN	WC9060R-01-PHN
		LAMINATED PHENOLIC	ROLLER	1500			WC9060-01-LPN	WC9060R-01-LPN
		POLYURETHANE ON CAST IRON	ROLLER	1250			WC9060-01-PCI	WC9060R-01-PCI
		POLYURETHANE ON ALUMINUM	ROLLER	1250			WC9060-01-PAL	WC9060R-01-PAL
		POLY-U / POLY-O (BLUE ON BLACK)	ROLLER	1000			WC9060-01-XLB	WC9060R-01-XLB
		RUBBER ON CAST IRON	ROLLER	500			WC9060-01-RCI	WC9060R-01-RCI
		ROUND THERMAL PLASTIC RUBBER	ROLLER	410			WC9060-01-RTP	WC9060R-01-RTP
		DUCTILE STEEL	ROLLER	1800			WC9060-01-DUC	WC9060R-01-DUC
		STEEL (CAST IRON)	ROLLER	1400			WC9060-01-STL	WC9060R-01-STL
		V-GROOVE (CAST IRON)	ROLLER	1400			WC9060-01-VG	WC9060R-01-VG
		SOLID POLYURETHANE	ROLLER	1200			WC9060-01-SPU	WC9060R-01-SPU
		SOLID POLYURETHANE/STL INSERT	6203 P.BB	1400			WC9060-01-SPUP	WC9060R-01-SPUP
YOKE ONLY	-	2000	WC9060-01-Y	WC9060R-01-Y				

WC 9000 SERIES

WHEEL	SWIVEL #	RIGID #	WHEEL																	
			TAPERED ROLLER	ROLLER	ROLLER	ROLLER														
8	2		1800	2000	1400	1750	1400	1500	1500	1100	1100	600	1300	1500	1400	1400	450	2000	WC9080-01-EPS-T	WC9080R-01-EPS-T
																			WC9080-01-DUC	WC9080R-01-DUC
																			WC9080-01-XDP	WC9080R-01-XDP
																			WC9080-01-LPN	WC9080R-01-LPN
																			WC9080-01-PHN	WC9080R-01-PHN
																			WC9080-01-PCI	WC9080R-01-PCI
																			WC9080-01-PAL	WC9080R-01-PAL
																			WC9080-01-XLB	WC9080R-01-XLB
																			WC9080-01-XLG	WC9080R-01-XLG
																			WC9080-01-RCI	WC9080R-01-RCI
																			WC9080-01-SPU	WC9080R-01-SPU
																			WC9080-01-SPUP	WC9080R-01-SPUP
																			WC9080-01-STL	WC9080R-01-STL
																			WC9080-01-VG	WC9080R-01-VG
																			WC9080-01-GRND	WC9080R-01-GRND
																			WC9080-01-Y	WC9080R-01-Y

*TO ORDER 8" CASTER WITH ALTERNATE 9-1/2" OVERALL HEIGHT, ADD AN "H" TO THE PART NUMBER, EXAMPLE: WC9080H-01-SPUP

FASTENERS FOR WC 9000 SERIES			
FASTENER TYPE	CODE	SIZE	
TOP PLATE	01	OVERALL SIZE:	4 x 4-1/2
		BOLT HOLE PATTERN:	2-5/8 x 3-5/8 SLOTTED TO 3 x 3
		ATTACHING BOLT SIZE:	3/8

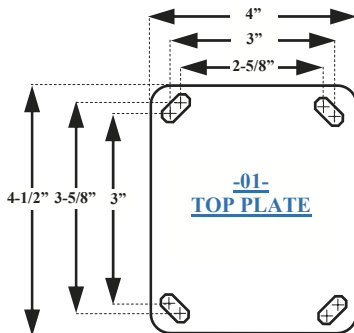

BEARING OPTIONS:	
(Add the desired bearing option abbreviation after the wheel designator). Example: WC9060-01-XDP-BB	
DELTRIN BEARINGS 3/4" I.D. W/ STEEL SPANNER TO 1/2"	DBO
DELTRIN BEARINGS 3/4" I.D. W/ DELTRIN SPANNER TO 1/2"	DBD
DELTRIN BEARINGS 1/2" I.D.	DB
ROLLER BEARINGS WITH ALL METAL COMPONENTS (A must for high-temp applications)	AMC
SEALED PRECISION BALL BEARINGS (See bearing explanation & picture on the bottom of the page)	BB

OPTIONS FOR WC 9000 SERIES

(Add option abbreviation to end of the caster part #)



Use Sealed Precision Ball Bearings in any wheel instead of Roller Bearings!

Sealed precision ball bearings provide a low maintenance, ergonomic ride with minimal effort to start-up and push loads. To order, change the part number as follows: Add a -BB, after the wheel designation. (Example: Standard roller bearing caster, WC9080-01-XLG. Caster with Sealed precision bearings, WC9080-01-XLG-BB).

WC 9100 SERIES



- Single ball bearing, precision machined, hardened & heat treated, “Kingpinless style sealed raceway.” (3.26” diameter raceway with 1/2” ball bearings.)
- Eliminates problems associated with kingpin failure.
- Legs are formed from 1/4” forged steel and are double welded for strength.
- Corrosion-resistant zinc plated finish.
- 1/2” diameter axle bolt with lock nut. Zerk grease fitting in axle & raceway.
- Applications: Great for applications involving extreme shock loading, towing, moving over cracks, uneven floors, and tarmacs, heavy mobile machinery & equipment, heavy-duty material handling carts, buggies & platform trucks, ground support equipment, heavy duty warehouse and manufacturing plant applications, etc.

WHEEL	WHEEL	WHEEL	WHEEL	WHEEL	WHEEL	WHEEL	SWIVEL #		RIGID #	
4	2	DUCTILE STEEL	ROLLER	1500	3-1/4	5-11/16	WC9140-01-DUC	WC9140R-01-DUC		
		LAMINATED PHENOLIC	ROLLER	1000			WC9140-01-LPN	WC9140R-01-LPN		
		PHENOLIC	ROLLER	800			WC9140-01-PHN	WC9140R-01-PHN		
		DURAPLAS (POLYOLEFIN)	ROLLER	700			WC9140-01-XDP	WC9140R-01-XDP		
		POLYURETHANE ON CAST IRON	ROLLER	800			WC9140-01-PCI	WC9140R-01-PCI		
		POLYURETHANE ON ALUMINUM	ROLLER	800			WC9140-01-PAL	WC9140R-01-PAL		
		POLY-U / POLY-O (BLUE ON BLACK)	ROLLER	800			WC9140-01-XLB	WC9140R-01-XLB		
		RUBBER ON CAST IRON	ROLLER	350			WC9140-01-RCI	WC9140R-01-RCI		
		SOLID POLYURETHANE	ROLLER	800			WC9140-01-SPU	WC9140R-01-SPU		
		SOLID POLYURETHANE /STL INSERT	6203 P.BB	900			WC9140-01-SPUP	WC9140R-01-SPUP		
STEEL (CAST IRON)	ROLLER	1000	WC9140-01-STL	WC9140R-01-STL						
V-GROOVE (CAST IRON)	ROLLER	1000	WC9140-01-VG	WC9140R-01-VG						
YOKE ONLY	-	2200	WC9140-01-Y	WC9140R-01-Y						
5	2	DUCTILE STEEL	ROLLER	1650	4	6-9/16	WC9150-01-DUC	WC9150R-01-DUC		
		DURAPLAS (POLYOLEFIN)	ROLLER	1200			WC9150-01-XDP	WC9150R-01-XDP		
		LAMINATED PHENOLIC	ROLLER	1250			WC9150-01-LPN	WC9150R-01-LPN		
		PHENOLIC	ROLLER	1000			WC9150-01-PHN	WC9150R-01-PHN		
		POLYURETHANE ON CAST IRON	ROLLER	1200			WC9150-01-PCI	WC9150R-01-PCI		
		POLYURETHANE ON ALUMINUM	ROLLER	1200			WC9150-01-PAL	WC9150R-01-PAL		
		POLY-U / POLY-O (BLUE ON BLACK)	ROLLER	1000			WC9150-01-XLB	WC9150R-01-XLB		
		RUBBER ON CAST IRON	ROLLER	450			WC9150-01-RCI	WC9150R-01-RCI		
		SOLID POLYURETHANE	ROLLER	1000			WC9150-01-SPU	WC9150R-01-SPU		
		SOLID POLYURETHANE /STL INSERT	6203 P.BB	1200			WC9150-01-SPUP	WC9150R-01-SPUP		
STEEL (CAST IRON)	ROLLER	1000	WC9150-01-STL	WC9150R-01-STL						
V-GROOVE (CAST IRON)	ROLLER	1100	WC9150-01-VG	WC9150R-01-VG						
YOKE ONLY	-	2200	WC9150-01-Y	WC9150R-01-Y						
6	2	EXTREME POLYURETHANE / STEEL	TAPERED	1600	4-3/4	7-1/2	WC9160-01-EPS-T	WC9160R-01-EPS-T		
		BALLOON CUSHION	BALL	400			WC9160-01-GRND	WC9160R-01-GRND		
		POLYURETHANE	PLAIN	700			WC9160-01-HDP-PB	WC9160R-01-HDP-PB		
		DURAPLAS (POLYOLEFIN)	6203 P.BB	1300			WC9160-01-XDPP	WC9160R-01-XDPP		
		DURAPLAS (POLYOLEFIN)	OILITE	1200			WC9160-01-XDPO	WC9160R-01-XDPO		
		DURAPLAS (POLYOLEFIN)	PLAIN	1200			WC9160-01-XDP-PB	WC9160R-01-XDP-PB		
		DURAPLAS (POLYOLEFIN)	ROLLER	1200			WC9160-01-XDP	WC9160R-01-XDP		
		THERMAL PLASTIC RUBBER	ROLLER	410			WC9160-01-TPR	WC9160R-01-TPR		
		LAMINATED PHENOLIC	ROLLER	1500			WC9160-01-LPN	WC9160R-01-LPN		
		PHENOLIC	ROLLER	1200			WC9160-01-PHN	WC9160R-01-PHN		
		POLYURETHANE ON CAST IRON	ROLLER	1250			WC9160-01-PCI	WC9160R-01-PCI		
		POLYURETHANE ON ALUMINUM	ROLLER	1250			WC9160-01-PAL	WC9160R-01-PAL		
		POLY-U / POLY-O (BLUE ON BLACK)	ROLLER	1000			WC9160-01-XLB	WC9160R-01-XLB		
		RUBBER ON CAST IRON	ROLLER	500			WC9160-01-RCI	WC9160R-01-RCI		
		ROUND THERMAL PLASTIC RUBBER	ROLLER	410			WC9160-01-RTP	WC9160R-01-RTP		
		DUCTILE STEEL	ROLLER	1800			WC9160-01-DUC	WC9160R-01-DUC		
STEEL (CAST IRON)	ROLLER	1400	WC9160-01-STL	WC9160R-01-STL						
V-GROOVE (CAST IRON)	ROLLER	1400	WC9160-01-VG	WC9160R-01-VG						
SOLID POLYURETHANE	ROLLER	1200	WC9160-01-SPU	WC9160R-01-SPU						
SOLID POLYURETHANE /STL INSERT	6203 P.BB	1400	WC9160-01-SPUP	WC9160R-01-SPUP						
YOKE ONLY	-	2200	WC9160-01-Y	WC9160R-01-Y						



WC 9100 SERIES

		WHEEL				SWIVEL #	RIGID #	
8	2	EXTREME POLYURETHANE / STEEL	TAPERED	1800	5-7/8	10-1/8	WC9180-01-EPS-T	WC9180R-01-EPS-T
		DUCTILE STEEL	ROLLER	2000			WC9180-01-DUC	WC9180R-01-DUC
		DURAPLAS (POLYOLEFIN)	ROLLER	1400			WC9180-01-XDP	WC9180R-01-XDP
		LAMINATED PHENOLIC	ROLLER	1750			WC9180-01-LPN	WC9180R-01-LPN
		PHENOLIC	ROLLER	1400			WC9180-01-PHN	WC9180R-01-PHN
		POLYURETHANE ON CAST IRON	ROLLER	1500			WC9180-01-PCI	WC9180R-01-PCI
		POLYURETHANE ON ALUMINUM	ROLLER	1500			WC9180-01-PAL	WC9180R-01-PAL
		POLY-U / POLY-O (BLUE ON BLACK)	ROLLER	1100			WC9180-01-XLB	WC9180R-01-XLB
		POLY-U / POLY-O (GRAY ON BEIGE)	ROLLER	1100			WC9180-01-XLG	WC9180R-01-XLG
		RUBBER ON CAST IRON	ROLLER	600			WC9180-01-RCI	WC9180R-01-RCI
		SOLID POLYURETHANE	ROLLER	1300			WC9180-01-SPU	WC9180R-01-SPU
		SOLID POLYURETHANE /STL INSERT	6203 P.BB	1500			WC9180-01-SPUP	WC9180R-01-SPUP
		STEEL (CAST IRON)	ROLLER	1400			WC9180-01-STL	WC9180R-01-STL
		V-GROOVE (CAST IRON)	ROLLER	1400			WC9180-01-VG	WC9180R-01-VG
		BALLOON CUSHION ON ALUMINUM	BALL	450			WC9180-01-GRND	WC9180R-01-GRND
		YOKE ONLY	-	2200			WC9180-01-Y	WC9180R-01-Y

FASTENERS FOR WC 9100 SERIES		
FASTENER TYPE	CODE	SIZE
TOP PLATE	01	OVERALL SIZE: 4-1/2 x 6-1/4 BOLT HOLE SPACING: 2-7/16 x 4-15/16 SLOTTED TO 3-3/8 x 5-1/4 ATTACHING BOLT SIZE: 1/2

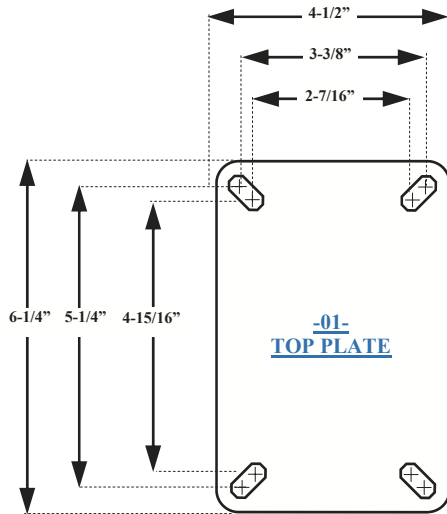

BEARING OPTIONS:	
(Add the desired bearing option abbreviation after the wheel designator). Example: WC9160-01-XDP-BB	
DELIN BEARINGS 3/4" I.D. W/ STEEL SPANNER TO 1/2"	DBO
DELIN BEARINGS 3/4" I.D. W/ DELIN SPANNER TO 1/2"	DBD
DELIN BEARINGS 1/2" I.D.	DB
ROLLER BEARINGS WITH ALL METAL COMPONENTS (A must for high-temp applications)	AMC
SEALED PRECISION BALL BEARINGS (See bearing explanation & picture on the bottom of the page)	BB

OPTIONS FOR WC 9100

(Add option abbreviation to end of the caster part #)

INTEGRATED TLB



TLB

POSITION LOCK



PSL

THREAD GAURDS



TG

SPECIAL FINISHES (FACTORY ORDER)

POLISHED GOLD FINISH	PGF
BLACK OXIDE	BO
NICKLE	N
CHROME	CR

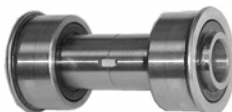

Use Sealed Precision Ball Bearings in any wheel instead of Roller Bearings!

Sealed precision ball bearings provide a low maintenance, ergonomic ride with minimal effort to start-up and push loads. To order, change the part number as follows: Add a -BB, after the wheel designation. (Example: Standard roller bearing caster, WC9180-01-XLG. Caster with Sealed precision bearings, WC9180-01-XLG-BB).

WC 9200 SERIES



- Single ball bearing, precision machined, hardened & heat treated, “Kingpinless style sealed raceway.” (3.26” diameter raceway with 1/2” ball bearings.)
- Eliminates problems associated with kingpin failure.
- Legs are formed from 23/64” forged steel and are double-welded for strength.
- Corrosion-resistant zinc plated finish.
- Zerk fittings in swivel raceway, axle and most wheels.
- 3/4” diameter axle bolt with lock nut. Zerk grease fitting in axle & raceway.
- Applications: Great for applications involving extreme shock loading, towing, moving over cracks, uneven floors, and tarmacs, heavy mobile machinery & equipment, heavy-duty material handling carts, buggies & platform trucks, ground support equipment, heavy duty warehouse and manufacturing plant applications, etc.

		WHEEL					SWIVEL #	RIGID #
6	2-1/2	EXTREME POLYURETHANE / STEEL PHENOLIC LAMINATED PHENOLIC POLYURETHANE ON CAST IRON RUBBER ON CAST IRON STEEL (CAST IRON) DUCTILE STEEL DUCTILE V-GROOVE V-GROOVE (CAST IRON) YOKE ONLY	TAPERED ROLLER ROLLER ROLLER ROLLER ROLLER ROLLER ROLLER ROLLER - 2200	2200 2000 2200 2000 750 2200 2200 2200 2000 2200	4-5/8	7-3/4	WC9260-01-EPS-T WC9260-01-PHN WC9260-01-LPN WC9260-01-PCI WC9260-01-RCI WC9260-01-STL WC9260-01-DUC WC9260-01-DVG WC9260-01-VG WC9260-01-Y	WC9260R-01-EPS-T WC9260R-01-PHN WC9260R-01-LPN WC9260R-01-PCI WC9260R-01-RCI WC9260R-01-STL WC9260R-01-DUC WC9260R-01-DVG WC9260R-01-VG WC9260R-01-Y
8	2-1/2	EXTREME POLYURETHANE / STEEL PHENOLIC LAMINATED PHENOLIC POLYURETHANE ON CAST IRON RUBBER ON CAST IRON STEEL (CAST IRON) DUCTILE STEEL DUCTILE V-GROOVE V-GROOVE (CAST IRON) YOKE ONLY	TAPERED ROLLER ROLLER ROLLER ROLLER ROLLER ROLLER ROLLER ROLLER - 2200	2200 2200 2200 2200 900 2200 2200 2200 2200 2200	6-3/8	10-1/8	WC9280-01-EPS-T WC9280-01-PHN WC9280-01-LPN WC9280-01-PCI WC9280-01-RCI WC9280-01-STL WC9280-01-DUC WC9280-01-DVG WC9280-01-VG WC9280-01-Y	WC9280R-01-EPS-T WC9280R-01-PHN WC9280R-01-LPN WC9280R-01-PCI WC9280R-01-RCI WC9280R-01-STL WC9280R-01-DUC WC9280R-01-DVG WC9280R-01-VG WC9280R-01-Y
10	2-1/2	EXTREME POLYURETHANE / STEEL PHENOLIC LAMINATED PHENOLIC POLYURETHANE ON CAST IRON RUBBER ON CAST IRON STEEL (CAST IRON) DUCTILE STEEL YOKE ONLY	TAPERED ROLLER ROLLER ROLLER ROLLER ROLLER ROLLER - 2200	2200 2200 2200 2200 1000 2700 2200 2200	7-3/4	11-3/4	WC9210-01-EPS-T WC9210-01-PHN WC9210-01-LPN WC9210-01-PCI WC9210-01-RCI WC9210-01-STL WC9210-01-DUC WC9210-01-Y	WC9210R-01-EPS-T WC9210R-01-PHN WC9210R-01-LPN WC9210R-01-PCI WC9210R-01-RCI WC9210R-01-STL WC9210R-01-DUC WC9210R-01-Y
12	2-1/2	EXTREME POLYURETHANE / STEEL PHENOLIC LAMINATED PHENOLIC POLYURETHANE ON CAST IRON RUBBER ON CAST IRON STEEL (CAST IRON) DUCTILE STEEL YOKE ONLY	TAPERED ROLLER ROLLER ROLLER ROLLER ROLLER ROLLER - 2200	2200 2200 2200 2200 1200 2200 2200 2200	9-1/2	13-3/4	WC9212-01-EPS-T WC9212-01-PHN WC9212-01-LPN WC9212-01-PCI WC9212-01-RCI WC9212-01-STL WC9212-01-DUC WC9212-01-Y	WC9212R-01-EPS-T WC9212R-01-PHN WC9212R-01-LPN WC9212R-01-PCI WC9212R-01-RCI WC9212R-01-STL WC9212R-01-DUC WC9212R-01-Y

WC 9200 SERIES

FASTENERS FOR WC 9200 SERIES		
FASTENER TYPE	CODE	SIZE
TOP PLATE	01	OVERALL SIZE: 4-1/2 x 6-1/4 BOLT HOLE SPACING: 2-7/16 x 4-15/16 SLOTTED TO 3-3/8 x 5-1/4 ATTACHING BOLT SIZE: 1/2

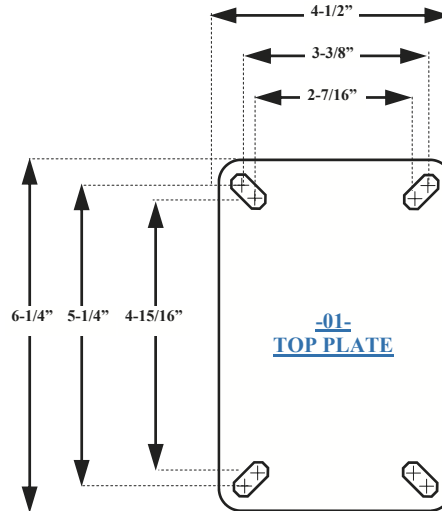

OPTIONS FOR WC 9200

(Add option abbreviation to end of the caster part #)

INTEGRATED
TLB



TLB

POSITION LOCK



PSL

SPECIAL FINISHES (FACTORY ORDER)	
POLISHED	PGF
GOLD FINISH	
BLACK OXIDE	BO
NICKLE	N
CHROME	CR

Use Tapered Bearings in any wheel instead of Roller Bearings!

We can install Tapered bearings in any of the wheels listed in this series of casters. Tapered bearings are more expensive than roller bearings, however they provide advantages that may justify the expense and may even save money by increasing wheel and caster life.

Tapered bearings are capable of higher loads and withstand more abuse than any other standard or common type of bearing used in the caster industry. Tapered bearings are a must for mechanically driven and continuous usage applications.

Not all wheel types are capable of withstanding the rigors of mechanically driven applications such as tow lines.

Accidents, injury or death may result from caster & wheel failure in motorized applications. We strongly suggest using our EPS = (Extreme-duty Polyurethane on Steel) wheel for all motorized applications (no caster or wheel should exceed 5 miles per hour).

To order tapered bearings in any of the above casters, add a -T to the end of the part number.

(Example: Standard roller bearing caster WC9280-01-PCI, Tapered bearing caster WC9280-01-PCI-T)

Please consult your distributor for advice on determining the correct caster, wheel & bearings to use in your application.



WC 9400 SERIES



- Single ball bearing, precision machined, hardened & heat treated, “Kingpinless style sealed raceway.” (3.43” diameter raceway with 1/2” ball bearings.)
- Top plate and yoke assembly : AISI 1045 drop forged steel. Legs are formed from 23/64” forged steel and are double welded for strength.
- Eliminates problems associated with kingpin failure.
- Corrosion-resistant zinc plated finish.
- 3/4” diameter axle bolt with lock nut. Zerk grease fitting in axle & raceway
- Applications: Great for applications involving extreme shock loading, towing, moving over cracks, uneven floors, and tarmacs, heavy mobile machinery & equipment, Extra heavy-duty material handling carts, buggies & platform trucks, ground support equipment, Extra heavy-duty warehouse and manufacturing plant applications, A frames, etc.

		WHEEL					SWIVEL #	RIGID #
6	2-1/2	EXTREME POLYURETHANE / STEEL PHENOLIC LAMINATED PHENOLIC POLYURETHANE ON CAST IRON RUBBER ON CAST IRON STEEL (CAST IRON) DUCTILE STEEL DUCTILE V-GROOVE V-GROOVE (CAST IRON) YOKE ONLY	TAPERED ROLLER ROLLER ROLLER ROLLER ROLLER ROLLER ROLLER ROLLER	2750 2000 2500 2000 750 2500 3500 3500 2000 6000	5-1/4	7-3/4	WC9460-01-EPS-T WC9460-01-PHN WC9460-01-LPN WC9460-01-PCI WC9460-01-RCI WC9460-01-STL WC9460-01-DUC WC9460-01-DVG WC9460-01-VG WC9460-01-Y	WC9460R-01-EPS-T WC9460R-01-PHN WC9460R-01-LPN WC9460R-01-PCI WC9460R-01-RCI WC9460R-01-STL WC9460R-01-DUC WC9460R-01-DVG WC9460R-01-VG WC9460R-01-Y
8	2-1/2	EXTREME POLYURETHANE / STEEL PHENOLIC LAMINATED PHENOLIC POLYURETHANE ON CAST IRON RUBBER ON CAST IRON STEEL (CAST IRON) DUCTILE STEEL DUCTILE V-GROOVE V-GROOVE (CAST IRON) YOKE ONLY	TAPERED ROLLER ROLLER ROLLER ROLLER ROLLER ROLLER ROLLER	3125 2500 3125 2500 900 2500 3750 3750 2500 6000	6-1/16	10-1/8	WC9480-01-EPS-T WC9480-01-PHN WC9480-01-LPN WC9480-01-PCI WC9480-01-RCI WC9480-01-STL WC9480-01-DUC WC9480-01-DVG WC9480-01-VG WC9480-01-Y	WC9480R-01-EPS-T WC9480R-01-PHN WC9480R-01-LPN WC9480R-01-PCI WC9480R-01-RCI WC9480R-01-STL WC9480R-01-DUC WC9480R-01-DVG WC9480R-01-VG WC9480R-01-Y
10	2-1/2	EXTREME POLYURETHANE / STEEL PHENOLIC LAMINATED PHENOLIC POLYURETHANE ON CAST IRON RUBBER ON CAST IRON STEEL (CAST IRON) DUCTILE STEEL YOKE ONLY	TAPERED ROLLER ROLLER ROLLER ROLLER ROLLER	3750 2900 3625 3000 1000 2700 4000 6000	7-3/8	11-3/4	WC9410-01-EPS-T WC9410-01-PHN WC9410-01-LPN WC9410-01-PCI WC9410-01-RCI WC9410-01-STL WC9410-01-DUC WC9410-01-Y	WC9410R-01-EPS-T WC9410R-01-PHN WC9410R-01-LPN WC9410R-01-PCI WC9410R-01-RCI WC9410R-01-STL WC9410R-01-DUC WC9410R-01-Y
12	2-1/2	EXTREME POLYURETHANE / STEEL PHENOLIC LAMINATED PHENOLIC POLYURETHANE ON CAST IRON RUBBER ON CAST IRON STEEL (CAST IRON) YOKE ONLY	TAPERED ROLLER ROLLER ROLLER ROLLER	4000 3500 4375 3500 1200 2500 6000	8-15/16	13-3/4	WC9412-01-EPS-T WC9412-01-PHN WC9412-01-LPN WC9412-01-PCI WC9412-01-RCI WC9412-01-STL WC9412-01-Y	WC9412R-01-EPS-T WC9412R-01-PHN WC9412R-01-LPN WC9412R-01-PCI WC9412R-01-RCI WC9412R-01-STL WC9412R-01-Y

WC 9400 SERIES

FASTENERS FOR WC 9400 SERIES		
FASTENER TYPE	CODE	SIZE
TOP PLATE	01	OVERALL SIZE: 5-9/32 x 7-1/4 BOLT HOLE SPACING: 3-3/8 x 5-1/4 SLOTTED TO 4-1/8 x 6-1/8 ATTACHING BOLT SIZE: 1/2

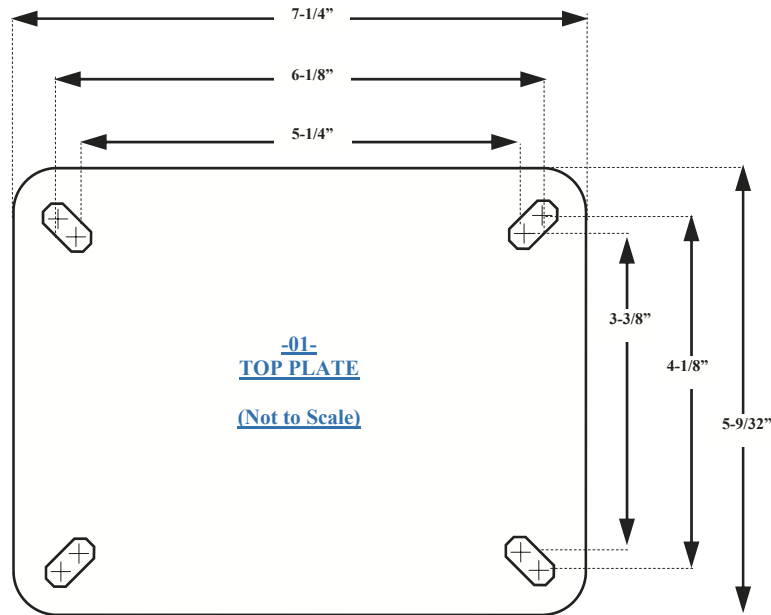

OPTIONS FOR WC 9400

(Add option abbreviation to end of the caster part #)

INTEGRATED
TLB



TLB

POSITION LOCK



PSL

SPECIAL FINISHES (FACTORY ORDER)

POLISHED	PGF
GOLD FINISH	
BLACK OXIDE	BO
NICKLE	N
CHROME	CR

Use Tapered Bearings in any wheel instead of Roller Bearings!

We can install Tapered bearings in any of the wheels listed in this series of casters. Tapered bearings are more expensive than roller bearings, however they provide advantages that may justify the expense and may even save money by increasing wheel and caster life.

Tapered bearings are capable of higher loads and withstand more abuse than any other standard or common type of bearing used in the caster industry. Tapered bearings are a must for mechanically driven and continuous usage applications.

Not all wheel types are capable of withstanding the rigors of mechanically driven applications such as tow lines.

Accidents, injury or death may result from caster & wheel failure in motorized applications. We strongly suggest using our EPS = (Extreme-duty Polyurethane on Steel) wheel for all motorized applications (no caster or wheel should exceed 5 miles per hour).

To order tapered bearings in any of the above casters, add a -T to the end of the part number.

(Example: Standard roller bearing caster WC9480-01-PCI, Tapered bearing caster WC9480-01-PCI-T)

Please consult your distributor for advice on determining the correct caster, wheel & bearings to use in your application.



WC 9500 SERIES



- Single ball bearing, precision machined, hardened & heat treated, “Kingpinless style sealed raceway.” (3.43” diameter raceway with 1/2” ball bearings.)
- Top plate and yoke assembly : AISI 1045 drop forged steel. Legs are formed from 23/64” forged steel and are double welded for strength.
- Eliminates problems associated with kingpin failure.
- Corrosion-resistant zinc plated finish.
- 3/4” diameter axle bolt with lock nut. Zerk grease fitting in axle & raceway
- Applications: Great for applications involving extreme shock loading, towing, moving over cracks, uneven floors, and tarmacs, heavy mobile machinery & equipment, Extra heavy-duty material handling carts, buggies & platform trucks, ground support equipment, Extra heavy-duty warehouse and manufacturing plant applications, A frames, etc.

		WHEEL					SWIVEL #	RIGID #
6	3	EXTREME POLYURETHANE / STEEL PHENOLIC LAMINATED PHENOLIC POLYURETHANE ON CAST IRON RUBBER ON CAST IRON STEEL (CAST IRON) V GROOVE (CAST IRON) DUCTILE STEEL DUCTILE V-GROOVE YOKE ONLY	TAPERED ROLLER ROLLER ROLLER ROLLER ROLLER ROLLER ROLLER ROLLER ROLLER ROLLER -	3500 2000 2500 2000 750 2500 2500 4500 4500 6000	5-1/16	7-3/4	WC9560-01-EPS-T WC9560-01-PHN WC9560-01-LPN WC9560-01-PCI WC9560-01-RCI WC9560-01-STL WC9560-01-VG WC9560-01-DUC WC9560-01-DVG WC9560-01-Y	WC9560R-01-EPS-T WC9560R-01-PHN WC9560R-01-LPN WC9560R-01-PCI WC9560R-01-RCI WC9560R-01-STL WC9560R-01-VG WC9560R-01-DUC WC9560R-01-DVG WC9560R-01-Y
8	3	EXTREME POLYURETHANE / STEEL PHENOLIC LAMINATED PHENOLIC POLYURETHANE ON CAST IRON RUBBER ON CAST IRON STEEL (CAST IRON) DUCTILE STEEL DUCTILE V-GROOVE V-GROOVE (CAST IRON) YOKE ONLY	TAPERED ROLLER ROLLER ROLLER ROLLER ROLLER ROLLER ROLLER ROLLER ROLLER -	4250 2500 3125 2500 900 2500 4750 4750 2800 6000	6-1/4	10-1/8	WC9580-01-EPS-T WC9580-01-PHN WC9580-01-LPN WC9580-01-PCI WC9580-01-RCI WC9580-01-STL WC9580-01-DUC WC9580-01-DVG WC9580-01-VG WC9580-01-Y	WC9580R-01-EPS-T WC9580R-01-PHN WC9580R-01-LPN WC9580R-01-PCI WC9580R-01-RCI WC9580R-01-STL WC9580R-01-DUC WC9580R-01-DVG WC9580R-01-VG WC9580R-01-Y
10	3	EXTREME POLYURETHANE / STEEL PHENOLIC LAMINATED PHENOLIC POLYURETHANE ON CAST IRON RUBBER ON CAST IRON STEEL (CAST IRON) DUCTILE STEEL YOKE ONLY	TAPERED ROLLER ROLLER ROLLER ROLLER ROLLER ROLLER -	4625 2900 3625 3000 1000 2700 5000 6000	7-3/8	11-3/4	WC9510-01-EPS-T WC9510-01-PHN WC9510-01-LPN WC9510-01-PCI WC9510-01-RCI WC9510-01-STL WC9510-01-DUC WC9510-01-Y	WC9510R-01-EPS-T WC9510R-01-PHN WC9510R-01-LPN WC9510R-01-PCI WC9510R-01-RCI WC9510R-01-STL WC9510R-01-DUC WC9510R-01-Y
12	3	EXTREME POLYURETHANE / STEEL PHENOLIC LAMINATED PHENOLIC POLYURETHANE ON CAST IRON RUBBER ON CAST IRON STEEL (CAST IRON) YOKE ONLY	TAPERED ROLLER ROLLER ROLLER ROLLER ROLLER -	5000 3500 4375 3500 1200 2500 6000	8-15/16	13-3/4	WC9512-01-EPS-T WC9512-01-PHN WC9512-01-LPN WC9512-01-PCI WC9512-01-RCI WC9512-01-STL WC9512-01-Y	WC9512R-01-EPS-T WC9512R-01-PHN WC9512R-01-LPN WC9512R-01-PCI WC9512R-01-RCI WC9512R-01-STL WC9512R-01-Y

WC 9500 SERIES

FASTENERS FOR WC 9500 SERIES

TOP PLATE	01	OVERALL SIZE: 5-9/32 x 7-1/4 BOLT HOLE SPACING: 3-3/8 x 5-1/4 SLOTTED TO 4-1/8 x 6-1/8 ATTACHING BOLT SIZE: 1/2
-----------	----	---

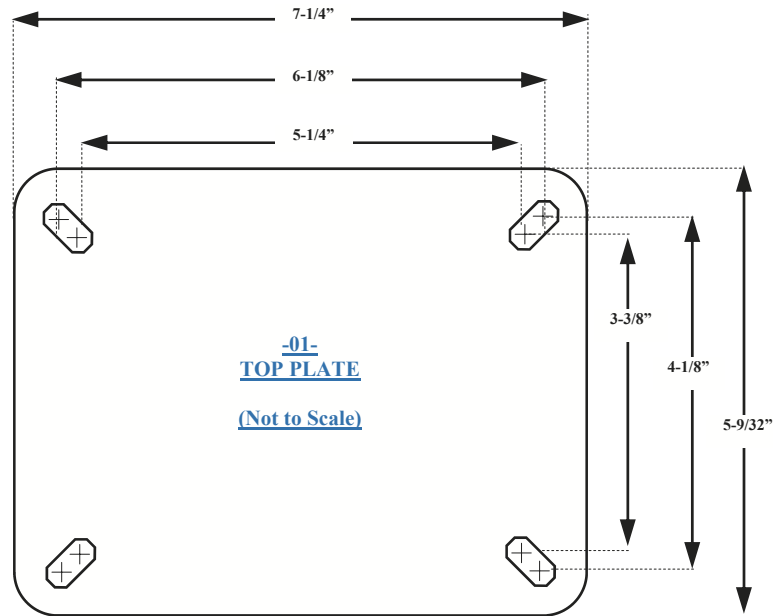

OPTIONS FOR WC 9500

(Add option abbreviation to end of the caster part #)

INTEGRATED
TLB



TLB

POSITION LOCK



PSL

SPECIAL FINISHES (FACTORY ORDER)

POLISHED	PGF
GOLD FINISH	
BLACK OXIDE	BO
NICKLE	N
CHROME	CR

Use Tapered Bearings in any wheel instead of Roller Bearings!

We can install Tapered bearings in any of the wheels listed in this series of casters. Tapered bearings are more expensive than roller bearings, however they provide advantages that may justify the expense and may even save money by increasing wheel and caster life.

Tapered bearings are capable of higher loads and withstand more abuse than any other standard or common type of bearing used in the caster industry. Tapered bearings are a must for mechanically driven and continuous usage applications.

Not all wheel types are capable of withstanding the rigors of mechanically driven applications such as tow lines.

Accidents, injury or death may result from caster & wheel failure in motorized applications. We strongly suggest using our EPS = (Extreme-duty Polyurethane on Steel) wheel for all motorized applications (no caster or wheel should exceed 5 miles per hour).

To order tapered bearings in any of the above casters, add a -T to the end of the part number.

(Example: Standard roller bearing caster WC9580-01-PCI, Tapered bearing caster WC9580-01-PCI-T)

Please consult your distributor for advice on determining the correct caster, wheel & bearings to use in your application.



OPTIONS & COMPONENTS

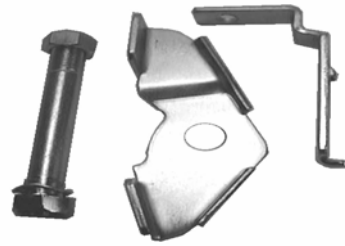

PEDAL WHEEL BRAKES			
Stainless frame, steel rivets, black poly pedal. (Comes with 3/8" zinc plated hex axle & nut)			
USE WITH WHEEL SIZE	USE IN SERIES	AXLE SIZE	PART NUMBER
3 x 1-1/4	WC 4030, WC 5230	3/8	PWB-5230
3.5 x 1-1/4	WC 5235		PWB-5235
4 x 1-1/4	WC 5040, WC 5240		PWB-5240
5 x 1-1/4	WC 3850, WC 5250		PWB-5250



PEDAL WHEEL BRAKES			
All stainless steel with gray poly pedal. (Comes with stainless steel 3/8" hex axle & nut)			
USE WITH WHEEL SIZE	USE IN SERIES	AXLE SIZE	PART NUMBER
3 x 1-1/4	WC S5230	3/8	SPWB-5230
3.5 x 1-1/4	WC S5235		SPWB-5235
4 x 1-1/4	WC S5240		SPWB-5240
5 x 1-1/4	WC S5250		SPWB-5250



POSITION-LOCKS (BOLT ON, TYPE)	
CASTER SERIES USED ON	PART #
WC 6600, WC P7600, WC 9000	PSL-6600-WR
WC 6800, WC 9100, WC 9200	PSL-9100-WR
WC 9400, WC 9500	PSL-9500-WR

POSITION LOCK BRAKES MAY BE ORDERED WELDED ON TO SWIVELYOKE.

TOP LOCK BRAKES (TLB)					
USE WITH WHEEL SIZE	USE IN SERIES SIZE	AXLE SIZE	I = Intergraded style (NEW) O = old Style	PART NUMBER	
2 x 15/16	WC 4020	1/4	I	TLB-4020	
2 x 1	WC3820	5/16	I	TLB-3820	
2-1/2 x 1-1/8	WC 4025	5/16	I	TLB-4025	
2-1/2 x 1-1/8	WC 3825	5/16	I	TLB-3825	
2-1/2 x 1-3/4	WC 5625	3/8	I	TLB-5625	
3 x 1	WC 3430, WC 3630	5/16	O	TLB-3630	
3 x 1-1/4	WC 3830	5/16	O	TLB-3830	
3 x 1-1/4	WC 4030, WC 5030, WC 5230	3/8	I	TLB-5230	
3 x 1-13/16	WC 5630	3/8	I	TLB-5630	
3-1/2 x 1-1/4	WC 5035, WC 5235	3/8	I	TLB-5235	
4 x 1	WC 3440, WC 3640	5/16	O	TLB-3640	
4 x 1-1/4	WC 3840	3/8	I (WITH HALF MOON CUT OUT)	TLB-3840	
4 x 1-1/4	WC 5040, WC 5240	3/8	I	TLB-5240	
4 x 1-1/2	WC 4040	3/8	O	TLB-4040	
4 x 1-1/2	WC 5540	3/8	I	TLB-5540	
4 x 2	WC 5640	1/2	I	TLB-5640	
4-1/2 & 4 x 2	WC 6440, WC 6640, WC 6740, WC 6840, WC 9040	1/2	I	TLB-6640	
5 x 1	WC 3450, WC 3600	5/16	O	TLB-3650	
5 x 1-1/4	WC 3850	3/8	I (WITH HALF MOON CUT OUT)	TLB-3850	
5 x 1-1/4	WC 5050, WC 5250	3/8	I	TLB-5250	
5 x 1-1/2	WC 5550	3/8	I	TLB-5550	
5 x 2	WC 5650	1/2	I	TLB-5650	
5-1/2 & 5 x 2	WC 6450, WC 6650, WC 6850, WC 9050	1/2	I	TLB-6650	
6 x 1-1/4	WC5060, WC 5260	3/8	I	TLB-5260	
6 x 1-1/2	WC 5560	1/2	I	TLB-5560	
6 x 2	WC 5660	1/2	I	TLB-5660	
6-1/2 & 6 x 2	WC 6460, WC 6660, WC 6860, WC 9060	1/2	I	TLB-6660	
6 x 2-1/2	**WC 9260	3/4	I	**TLB-9260	
6 x 2-1/2 & 6 x 3	**WC 9460, WC 9560	3/4	I	**TLB-9560	
8 x 2	WC 6680, WC 6880, WC 9080	1/2	I	TLB-6680	
8 x 2-1/2	**WC 9280	3/4	I	**TLB-9280	
8 x 2-1/2 & 8 x 3	**WC 9480, WC 9580	3/4	I	**TLB-9580	
8" & 9"	PNEUMATIC CASTER WC P7680 & *WC P7690	1/2	O	*PTLB-7690	
10 x 2-1/2	**WC 9210	3/4	I	**TLB-9210	
10 x 2-1/2 & 10 x 3	**WC 9410, WC 9510	3/4	I	**TLB-9510	
10	PNEUMATIC CASTER WC P7610	1/2	O	PTLB-7610	
12 x 2-1/2	**WC 9212	3/4	I	**TLB-9212	
	**WC 9412, WC 9512	3/4	I	**TLB-9512	
12	PNEUMATIC CASTER WC P7612	1/2	O	PTLB-7612	

*POLISHED GOLD/BRASS FINISH AVAILABLE, ORDER AS: PTLB-7690-PGF
 ** SOME COMPLICATIONS MAY ARRISE DUE TO DIFFERENCES IN DIAMETERS AND TREAD FACES ON VARIOUS WHEELS, SOME ADJUSTMENTS MAY BE NEEDED TO WORK CORRECTLY. YOU MAY WANT TO ORDER THESE SERIES BRAKE CASTERS COMPLETE FROM US.



OPTIONS & COMPONENTS



TOP LOCK BRAKES, STAINLESS STEEL (STLB)

USE WITH WHEEL SIZE	USE IN SERIES SIZE	AXLE SIZE	I = Intergrated style (NEW) O = old Style	PART NUMBER
3 x 1-1/4	WC S5030, WC S5230	3/8	I	STLB-5230
3-1/2 x 1-1/4	WC S5035, WC S5235	3/8	I	STLB-5235
4 x 1-1/4	WC S5040, WC S5240	3/8	I	STLB-5240
4-1/2 & 4 x 2	WC S6640	1/2	I	STLB-6640
5 x 1-1/4	WC S5050, WC S5250	3/8	I	STLB-5250
5 x 2	WC S6650	1/2	I	STLB-6650
6 x 1-1/4	WC S5060, WC S5260	3/8	I	STLB-5260
6 x 2	WC S6660	1/2	I	STLB-6660
8 x 2	WC S6680	1/2	I	STLB-6680

EXPANDABLE ADAPTERS KITS INCLUDE: BOTTOM WASHER, PLASTIC SUPPORT, RUBBER EXPANDERS & METAL FASTENER.

FOR TUBING SIZE	CASTER STEM DESIGNATION	KIT PART #
1-1/2" OD 1-3/8" ID	25	EXP-1-3/8
1-5/8" OD 1-1/2" ID	26	EXP-1.5
1" OD 7/8" ID	27	EXP-7/8
1-1/8" OD 1" ID	28	EXP-1
1-1/4" OD 1-1/8" ID	29	EXP-1-1/8



QUICK CHANGE PLATES ("TOOL-LESS TYPE") & WELD PLATES

TYPE OF PLATE	QCP: FOR PLATE SIZE WP: SIZE OF PLATE	PART NUMBER
ZINC PLATED QUICK CHANGE PLATE. DESIGNED TO BE ATTACHED TO EQUIPMENT USING A 5/16" SQUARE SHOULD BOLT.	OVERALL TOP PLATE SIZE: 2-1/2 x 3-5/8, THICKNESS: 5/32"	QCP-01-5200
UNPLATED QUICK CHANGE PLATE. DESIGNED TO BE WELDED TO EQUIPMENT.	FITS SERIES: WC 3800-01, WC 5000-01, WC 5200-01, WC 5700-01, WC 5500-01, WC 5600-01	QCP-01-5200-UNPLATED
ZINC PLATED QUICK CHANGE PLATE. DESIGNED TO BE ATTACHED TO EQUIPMENT USING A 5/16" SQUARE SHOULD BOLT.	OVERALL TOP PLATE SIZE: 4 x 4-1/2, 1/4" THICKNESS: 1/4"	QCP-01-6600
UNPLATED QUICK CHANGE PLATE. DESIGNED TO BE WELDED TO EQUIPMENT.	FITS SERIES: WC 5600-02, WC 6400-01, WC 6600-01, WC P7600-01, WC 9000-01	QCP-01-6600-UNPLATED
WELD PLATE (UNPLATED)	OVERALL SIZE: 2-1/2 x 3-5/8 BOLT HOLE PATTERN: 1-3/4 x 2-7/8 SLOTTED TO 3 THICKNESS: 5/32" ATTACHING BOLT SIZE: 5/16	WELD PLATE-5200
WELD PLATE (UNPLATED)	OVERALL SIZE: 4 x 1-1/2 BOLT HOLE PATTERN: 2-5/8 x 3-5/8 SLOTTED TO 3 x 3 THICKNESS: 1/4" ATTACHING BOLT SIZE: 3/8	WELD PLATE-6600
WELD PLATE (UNPLATED)	OVERALL SIZE: 4-1/2 x 6-1/4 BOLT HOLE PATTERN: 2-7/16 x 4-15/16 SLOTTED TO 3-3/8 x 5-1/4 THICKNESS: 1/4" ATTACHING BOLT SIZE: 3/8	WELD PLATE-6800

CORNER BUMPERS

COLOR	SIZE	PART#
GRAY	4 x 4	CORNER BUMPER
BLACK	4 x 4	CORNER BUMPER-B



FLOOR LOCKS

CORRESPONDING CASTER SIZE	LOWERED HEIGHT	EXTENDED HEIGHT	PART NUMBER
4	4-3/4	6	FL-4
5	5-1/2	6-1/2	FL-5
6	6-3/4	7-3/4	FL-6
8	8-5/8	9-5/8	FL-8

*Weld quick change plates to equipment with the clip facing towards the inside. This will prevent the clip that holds the caster in place from hitting objects that may cause it to become loose.

OPTIONS & COMPONENTS



AXLES AND NUTS			
DIAMETER	LENGTH	FOR SERIES (& SIZE)	PART #
ROUND HEAD AXLES:			
3/8	2-1/4	WC 4030, WC 3840, WC 3850, WC 5000, WC 5200, WC 5700, PWB-5200	YA1-CO6
PLAIN HEX AXLES:			
5/16	2-1/4		YA1-B07
3/8	2-1/4		YA1-B08
1/2	4-1/8	WC P7680, WC P7690	P-YA3-F11
1/2	5-3/16	WC P7610	P-YA3-H11
1/2	5-3/8	WC P7612	P-YA3-G11
ZERK AXLES:			
3/8	2-3/16	WC 4030, WC 3840, WC 3850, WC 5000, WC 5200, WC 5700	YA3-CO7
3/8	2-9/16	WC 5540, WC 5550, WC 5630	YA3-CO9
1/2	3	WC 6400	YA3-D11
1/2	3-3/8	WC 6600, WC 6800, WC 9000	YA3-E11
1/2	3-7/8	WC 68625, WC 68825	YA3-E11-LONG
3/4	4-1/2	WC 9200, WC 9400	YA3-F11
3/4	4-3/4	WC 9500	YA3-G11
STAINLESS STEEL (PLAIN AXLE)			
3/8	2-3/16	WC S5000, WC S5200	YA1-CO6-SS
3/8	2-1/4	WC S5200	YA-PWB-SS (FOR SPWB)
STAINLESS STEEL (ZERK AXLE)			
3/8	2-3/16	WC S5000, WC S5200	YA3-CO7-SS
1/2	3-3/8	WC S6600	YA3-E11-SS



SOCKETS (FOR 7/16 GRIP RING STEMS -11-)			
SOCKET TYPE	OUTER DIAMETER	TUBING SIZE & GAUGE	PART #
ROUND	.910	1" 16 G	S-7/8-RR
	.660	3/4" 16 G	S-5/8-RR
SQUARE	.935	1" 16 G	S-7/8-SQ
	.660	3/4" 16 G	S-5/8-SQ

SPANNER BUSHINGS				
OUTER DIAMETER	INNER DIAMETER	LENGTH	CROSS DRILLED HOLE	PART #
DELRIN:				
1/2	3/8	1-1/2	NO	YB2-E03
1/2	3/8	1-5/8	NO	YB2-E04
1/2	3/8	1-11/16	NO	YB2-E05
3/4	3/8	1-11/16	YES	YB2-E10
3/4	1/2	1-7/8	YES	YB2-E02
3/4	1/2	2-7/16	YES	YB2-E07
STEEL:				
3/4	5/8	2-7/16	YES	YB2-E13
3/8	5/16	1-5/8	NO	YB1-A03
1/2	3/8	1-5/8	YES	YB1-B03
1/2	3/8	1-11/16	YES	YB1-B04 (FOR HIGH TEMPS)
5/8	3/8	2-1/16	NO	YB2-C03
3/4	1/2	1-7/8	YES	YB2-E01
3/4	1/2	2-7/16	YES	YB2-E06
3/4	1/2	2-15/16	YES	YB2-G08
1	3/4	2-7/8	YES	YB2-F06
1	3/4	3-3/8	YES	YB2-G06
STAINLESS STEEL:				
1/2	3/8	1-5/8	YES	YB1-B03-SS
3/4	1/2	2-7/16	YES	YB2-E06-SS
TOP HAT BUSHINGS, OILITE STEEL "DUAL SPANNER WASHERS"				
1/2	3/8	1-7/16 INNER 1-5/8 OUTER	YES	DSW-PHN (FOR 1-1/4" FACE PHENOLIC WHEELS)
5/8	3/8	1.635 INNER 1-7/8 OUTER	NO	RBTHSB-5500 (FOR WC 5500 SERIES RB)
.6625	1/2	2.193 INNER 2.469 OUTER	NO	PBTHSB-6600 (FOR WC 6203 PRECISION BB)
316 STAINLESS STEEL TOP HAT BUSHINGS, "DUAL SPANNER WASHERS" (FOR USE IN STAINLESS STEEL CASTERS)				
1/2	3/8	1-7/16 INNER 1-5/8 OUTER	YES	DSW-PHN-SS (FOR 1-1/4" FACE PHENOLIC WHEELS)



OPTIONS & COMPONENTS



RETAINER WASHERS

WASHER TYPE	OUTER DIAMETER	INNER DIAMETER	PART #
DELRIN FLANGED	1-3/16	3/4	RW-6600
DELRIN BIG-LIP FLANGED	1-3/16	3/4	RW-6600B
METAL BIG LIP FLANGED	1-3/16	3/4	RWM-6600B
METAL, FLAT	1-3/16	3/4	RWM-6600
METAL FLAT	1-15/16	1	RW-9400
METAL FLAT	1-15/16	1-1/4	RW-9400-1.25

BEARINGS

(Part numbers are per piece, order 2 bearings for a set of Delrin, Ball bearings & Flanged roller bearings)

OUTER DIAMETER	INNER DIAMETER	LENGTH	PART #
DELRIN BEARINGS			
1-3/16	1/2	11/16	DB-6600
1-3/16	3/4	11/16	DB-6600.75
1-3/16	1/2	1-7/8	SDB-6600 (1 PIECE SOLID)
BALL BEARINGS (FLANGED STYLE) *Touch in the middle			
1-1/8	5/16	.82	*BB-5/16
1-1/8	3/8	.82	*BB-3/8
1-3/8	1/2	.55	P-1/2BB
1-3/8	5/8	.55	P-5/8BB
1-3/8	3/4	.55	P-3/4BB
STAINLESS STEEL, BALL BEARINGS (FLANGED STYLE) *Touch in the middle			
1-1/8	3/8	.82	*BB-3/8-SS
SEALED PRECISION BALL (FLANGED STYLE) *Touch in the middle			
1-3/16	1/2	1-1/4	*BB-6600
1-3/8	1/2	.515	P-1/2FPB
1-3/8	5/8	.515	P-5/8FPB
1-3/8	3/4	.515	P-3/4FPB
STAINLESS STEEL, SEALED PRECISION BALL (FLANGED STYLE) *Touch in the middle			
1-3/16	1/2	1-1/4	*BB-6600-SS
SEALED PRECISION BALL BEARINGS (FOR USE WITH TOP HAT BUSHINGS)			
1.572	.670	.70	6203-2RS
ROLLER BEARINGS			
1-3/16	3/4	1-3/8	RB-6400
1-3/16	3/4	1-7/8	RB-6600
1-3/16	3/4	2-1/2	RB-9400-(1-3/16)
1-3/8	3/4	2.72	P-RB-7610 (NO OUTER RACE)
1-15/16	1	2-1/2	RB-9400
1-15/16	1-1/4	2-1/2	RB-9400-(1-.25)
1-15/16	1	3	RB-9500
1-15/16	1-1/4	3	RB-9500-(1.25)
FLANGED ROLLER BEARINGS			
1-3/8	5/8	1-1/2	P-FRB-5/8
1-3/8	3/4	1-1/2	P-FRB-3/4
TAPERED BEARINGS: CUP {LM11910} & CONE: {LM11949}			
1.782	.753	.65	TB-9500

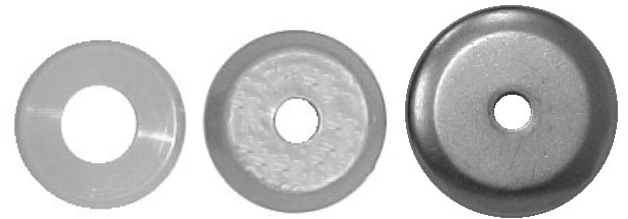

(BC) BEARING COVERS (PLASTIC) & (TG) THREAD GUARD (METAL)

COMMON WHEEL DIAMETER	OUTER DIAMETER	INNER DIAMETER	PART #
FOR ALL PPBG & TRB WHEELS (BEIGE)	1.495	3/8	BCG-5200
FOR ALL PAL WHEELS (BLUE)	1.615	3/8	BC-PAL
FOR ALL RAL WHEELS (GRAY)	1.615	3/8	BC-RAL
3	1.795	3/8	TG-5230-3/8
4	2.285	3/8	TG-5240-3/8
5	1.115	3/8	TG-5250-3/8
4	2-5/8	1/2	TG-6640
4 (PHN)	2.285	1/2	TG-6640-PHN
5	3-1/4	1/2	TG-6650
6	3.895	1/2	TG-6660
8	5.69	1/2	TG-6680

WHEELS

CENTIPEDE WHEEL



Centered Hub



Offset Hub

- New “Centipede” wheel is made out of microcellular polyurethane foam. It provides a lightweight, cushioned ride without worry, maintenance or a flat tire. The hub assembly is a durable 2 piece nylon construction. These wheels perform best with precision ball bearings.
- Black non-marking tread on a yellow Nylon hub makes for an attractive super lightweight wheel that can be used in various applications.
- Other colors available upon request, Sufficient quantities required. Please inquire.
- Other sizes could be developed, Please inquire.
- **Applications:** Carts, platform trucks for industrial, commercial and institutional environments demanding a cushioned ride. Carrying sensitive materials , chemicals, electronics, ceramics, glass, sound and lighting equipment. Great for use on equipment that may need to traverse different terrains, such as: generators, compressors, pressure washers, sprayers, snow-blowers, heaters & fans, vacuums, wheel-barrows, fertilizer spreaders, wagons, lawn & garden equipment, etc.

GENERIC WHEEL DIAMETER	TREAD WIDTH	HUB LENGTH	WEIGHT CAPACITY	BEARING I.D.	PART # BALL BEARING (ECONOMY)	PART # FLANGED PRECISION BALL	PLAIN BORE NO BEARING
CENTERED HUB							
10	3	3-29/32	250	1/2	P-W10-CH-C-1/2 P-W10-CH-CG-1/2 P-W10-CH-CKG-1/2	P-W10-CH-C-PB-1/2 P-W10-CH-CG-PB-1/2 P-W10-CH-CKG-PB-1/2	
				5/8	P-W10-CH-C-5/8 P-W10-CH-CG-5/8 P-W10-CH-CKG-5/8	P-W10-CH-C-PB-5/8 P-W10-CH-CG-PB-5/8 P-W10-CH-CKG-PB-5/8	
				3/4	P-W10-CH-C-3/4 P-W10-CH-CG-3/4 P-W10-CH-CKG-3/4	P-W10-CH-C-PB-3/4 P-W10-CH-CG-PB-3/4 P-W10-CH-CKG-PB-3/4	
OFFSET HUB							
10	3	2.442	250	1/2	P-W10-OH-C-1/2 P-W10-OH-CG-1/2 P-W10-OH-CKG-1/2	P-W10-OH-C-PB-1/2 P-W10-OH-CG-PB-1/2 P-W10-OH-CKG-PB-1/2	
				5/8	P-W10-OH-C-5/8 P-W10-OH-CG-5/8 P-W10-OH-CKG-5/8	P-W10-OH-C-PB-5/8 P-W10-OH-CG-PB-5/8 P-W10-OH-CKG-PB-5/8	P-W10-OH-CKK-PLB-5/8
				3/4	P-W10-OH-C-3/4 P-W10-OH-CG-3/4 P-W10-OH-CKG-3/4	P-W10-OH-C-PB-3/4 P-W10-OH-CG-PB-3/4 P-W10-OH-CKG-PB-3/4	

WHEELS

DUCTILE STEEL



- Made from premium Ductile Iron.
- Extra heavy core provides superior strength over standard Semi-steel wheels.
- Extra thick hub provides strength as well as the ability for it to be machined out for special bore sizes, bearing options and keyways.
- Wheel tread is fully machined to distribute the load across the entire surface.
- Resist's breaking, chipping & cracking.
- Minimal effort required to start-up and push loads.
- Great for applications requiring extreme temperatures.
- Temperature rating: -40 to +800 degrees Fahrenheit (All metal components should be used in applications over 180 degrees).
- Durometer: 225-265 Brinell

WHEEL DIAMETER	TREAD WIDTH	HUB LENGTH	WEIGHT CAPACITY	BEARING/ BUSHING I.D.	PART # ROLLER BEARINGS	PART # SEALED PRECISION BALL BEARINGS	PART # TAPERED ROLLER BEARING	PART# DELRIN BEARINGS	PART# DELRIN BEARINGS .75 W/ *STEEL SPANNER	PART # BLANK (NO BEARING)	BLANK WHEEL I.D.
4	2	2-3/16	1500	1/2	W-4-DUC-9100-C	W-4-DUC-9100-BB	N/A	W-4-DUC-9100-DB	W-4-DUC-9100-DBO	W-4-DUC-9100	1-3/16
5	2	2-3/16	1650	1/2	W-5-DUC-9100-C	W-5-DUC-9100-BB	N/A	W-5-DUC-9100-DB	W-5-DUC-9100-DBO	W-5-DUC-9100	1-3/16
6	2	2-3/16	1800	1/2	W-6-DUC-9100-C	W-6-DUC-9100-BB	N/A	W-6-DUC-9100-DB	W-6-DUC-9100-DBO	W-6-DUC-9100	1-3/16
6	2-1/2	2-3/4	3500	3/4	W-6-DUC-9400-C	N/A	W-6-DUC-9400-T	N/A	N/A	W-6-DUC-9400	1-15/16
6	2-1/2	2-3/4	3500	1	W-6-DUC-9400-C-1 (NO BUSHING)	N/A	NA	N/A	N/A	W-6-DUC-9400	1-15/16
6	2-1/2	2-3/4	3500	1-1/4	W-6-DUC-9400-C-1.25 (NO BUSHING)	N/A	NA	N/A	N/A	W-6-DUC-9400	1-15/16
6	3	3-1/4	4500	3/4	W-6-DUC-9500-C	N/A	W-6-DUC-9500-T	N/A	N/A	W-6-DUC-9500	1-15/16
6	3	3-1/4	4500	1	W-6-DUC-9500-C-1 (NO BUSHING)	N/A	NA	N/A	N/A	W-6-DUC-9500	1-15/16
6	3	3-1/4	4500	1-1/4	W-6-DUC-9500-C-1.25 (NO BUSHING)	N/A	NA	N/A	N/A	W-6-DUC-9500	1-15/16
8	2	2-3/16	2000	1/2	W-8-DUC-9100-C	W-8-DUC-9100-BB	N/A	W-8-DUC-9100-DB	W-8-DUC-9100-DBO	W-8-DUC-9100	1-3/16
8	2-1/2	2-3/4	3750	3/4	W-8-DUC-9400-C	N/A	W-8-DUC-9400-T	N/A	N/A	W-8-DUC-9400	1-15/16
8	2-1/2	2-3/4	3750	1	W-8-DUC-9400-C-1 (NO BUSHING)	N/A	NA	N/A	N/A	W-8-DUC-9400	1-15/16
8	2-1/2	2-3/4	3750	1-1/4	W-8-DUC-9400-C-1.25 (NO BUSHING)	N/A	NA	N/A	N/A	W-8-DUC-9400	1-15/16
8	3	3-1/4	4750	3/4	W-8-DUC-9500-C	N/A	W-8-DUC-9500-T	N/A	N/A	W-8-DUC-9500	1-15/16
8	3	3-1/4	4750	1	W-8-DUC-9500-C-1 (NO BUSHING)	N/A	NA	N/A	N/A	W-8-DUC-9500	1-15/16
8	3	3-1/4	4750	1-1/4	W-8-DUC-9500-C-1.25 (NO BUSHING)	N/A	NA	N/A	N/A	W-8-DUC-9500	1-15/16
10	2-1/2	2-3/4	4000	3/4	W-10-DUC-9400-C	N/A	W-10-DUC-9400-T	N/A	N/A	W-10-DUC-9400	1-15/16
10	2-1/2	2-3/4	4000	1	W-10-DUC-9400-C-1 (NO BUSHING)	N/A	NA	N/A	N/A	W-10-DUC-9400	1-15/16
10	2-1/2	2-3/4	4000	1-1/4	W-10-DUC-9400-C-1.25 (NO BUSHING)	N/A	NA	N/A	N/A	W-10-DUC-9400	1-15/16
10	3	3-1/4	5000	3/4	W-10-DUC-9500-C	N/A	W-10-DUC-9500-T	N/A	N/A	W-10-DUC-9500	1-15/16
10	3	3-1/4	5000	1	W-10-DUC-9500-C-1 (NO BUSHING)	N/A	NA	N/A	N/A	W-10-DUC-9500	1-15/16
10	3	3-1/4	5000	1-1/4	W-10-DUC-9500-C-1.25 (NO BUSHING)	N/A	NA	N/A	N/A	W-10-DUC-9500	1-15/16

* TO ORDER 3/4 DELRIN BEARING WITH DELRIN BUSHING INSTEAD OF STEEL CHANGE PART # FROM-DBO TO DBD, TO ORDER WITH STAINLESS STEEL BUSHING CHANGE TO -DBS.

WHEELS

DUCTILE V GROOVE



- Made from premium Ductile Iron.
- Extra heavy core provides superior strength over standard Semi-steel wheels.
- Extra thick hub provides strength as well as the ability for it to be machined out for special bore sizes, bearing options and keyways.
- Made for use on either angle iron track, a flat surface, or both.
- Wheel is machined in the center of the tread with a relief groove at the base of the “V” directing the load to each side of the groove
- Resist’s breaking, chipping & cracking.
- Minimal effort required to start-up and push loads.
- Great for applications requiring extreme temperatures.
- Temperature rating: -40 to +800 degrees Fahrenheit (All metal components should be used in applications over 180 degrees).
- Durometer: 225-265 Brinell

WHEEL DIAMETER	TREAD WIDTH	HUB LENGTH	WEIGHT CAPACITY	BEARING/ BUSHING I.D.	PART # ROLLER BEARINGS	PART # SEALED PRECISION BALL BEARINGS	PART # TAPERED ROLLER BEARING	PART# DELRIN BEARINGS	PART# DELRIN BEARINGS .75 W/ *STEEL SPANNER	PART # BLANK (NO BEARING)	BLANK WHEEL I.D.
4	2	2-3/16	1500	1/2	W-4-DVG-9100-C	W-4-DVG-9100-BB	N/A	W-4-DVG-9100-DB	W-4-DVG-9100-DBO	W-4-DVG-9100	1-3/16
5	2	2-3/16	1500	1/2	W-5-DVG-9100-C	W-5-DVG-9100-BB	N/A	W-5-DVG-9100-DB	W-5-DVG-9100-DBO	W-5-DVG-9100	1-3/16
6	2	2-3/16	1750	1/2	W-6-DVG-9100-C	W-6-DVG-9100-BB	N/A	W-6-DVG-9100-DB	W-6-DVG-9100-DBO	W-6-DVG-9100	1-3/16
6	2-1/2	2-3/4	3500	3/4	W-6-DVG-9400-C	N/A	W-6-DVG-9400-T	N/A	N/A	W-6-DVG-9400	1-15/16
6	2-1/2	2-3/4	3500	1	W-6-DVG-9400-C-1 (NO BUSHING)	N/A	NA	N/A	N/A	W-6-DVG-9400	1-15/16
6	2-1/2	2-3/4	3500	1-1/4	W-6-DVG-9400-C-1.25 (NO BUSHING)	N/A	NA	N/A	N/A	W-6-DVG-9400	1-15/16
6	3	3-1/4	4500	3/4	W-6-DVG-9500-C	N/A	W-6-DVG-9500-T	N/A	N/A	W-6-DVG-9500	1-15/16
6	3	3-1/4	4500	1	W-6-DVG-9500-C-1 (NO BUSHING)	N/A	NA	N/A	N/A	W-6-DVG-9500	1-15/16
6	3	3-1/4	4500	1-1/4	W-6-DVG-9500-C-1.25 (NO BUSHING)	N/A	NA	N/A	N/A	W-6-DVG-9500	1-15/16
8	2	2-3/16	2000	1/2	W-8-DVG-9100-C	W-8-DVG-9100-BB	N/A	W-8-DVG-9100-DB	W-8-DVG-9100-DBO	W-8-DVG-9100	1-3/16
8	2-1/2	2-3/4	3750	3/4	W-8-DVG-9400-C	N/A	W-8-DVG-9400-T	N/A	N/A	W-8-DVG-9400	1-15/16
8	2-1/2	2-3/4	3750	1	W-8-DVG-9400-C-1 (NO BUSHING)	N/A	NA	N/A	N/A	W-8-DVG-9400	1-15/16
8	2-1/2	2-3/4	3750	1-1/4	W-8-DVG-9400-C-1.25 (NO BUSHING)	N/A	NA	N/A	N/A	W-8-DVG-9400	1-15/16
8	3	3-1/4	4750	3/4	W-8-DVG-9500-C	N/A	W-8-DVG-9500-T	N/A	N/A	W-8-DVG-9500	1-15/16
8	3	3-1/4	4750	1	W-8-DVG-9500-C-1 (NO BUSHING)	N/A	NA	N/A	N/A	W-8-DVG-9500	1-15/16
8	3	3-1/4	4750	1-1/4	W-8-DVG-9500-C-1.25 (NO BUSHING)	N/A	NA	N/A	N/A	W-8-DVG-9500	1-15/16

* TO ORDER 3/4 DELRIN BEARING WITH DELRIN BUSHING INSTEAD OF STEEL CHANGE PART # FROM-DBO TO DBD, TO ORDER WITH STAINLESS STEEL BUSHING CHANGE TO -DBS.

WHEELS

EXTREME-DUTY POLYURETHANE ON STEEL



- Wheels made from a specially formulated Hy-Load compound polyurethane chemically bonded using a process called chemfused to a steel core. The chem-fused process actually makes the tensile strength of the bond stronger than the materials being bonded together. The combination of the Hy-load urethane chemfused to a steel core make this wheel one of the most long lasting rugged wheels available in the industry.
- Hy-load polyurethane is a real problem solver, it was developed to resist internal heat buildup. Excellent for applications where heavy loads and continuous usage may be causing standard type polyurethane wheels to heat up and degrade.
- 1" thick polyurethane tread offers floor protection, is non marking and delivers somewhat of a cushioned and quieter ride than a hard tread or steel wheel.
- Steel core is made with extra thick walls and oversized hub to withstand the toughest applications.
- EPS wheels come standard with Tapered bearings. Tapered bearings provide maximum roll-ability with the minimum amount of effort to start up and move a load. Tapered bearings are capable of taking higher load capacities and more abuse than any other standard type of bearing used in the industry.
- Resistant to most chemicals, oils, acids, grease and water.
- Temperature rating: -40 to 180.
- Durometer: 60 Shore D

WHEEL DIAMETER	TREAD WIDTH	HUB LENGTH	WEIGHT CAPACITY	BEARING/ BUSHING LD	PART # TAPERED ROLLER BEARING
6	2	2-3/16	1600	1/2	W-6-EPS-9100-T-1/2 (With bushing)
6	2-1/2	2-3/4	2750	3/4	W-6-EPS-9400-T
6	3	3-1/4	3500	3/4	W-6-EPS-9500-T
8	2	2-3/16	1800	1/2	W-8-EPS-9100-T-1/2 (With bushing)
8	2-1/2	2-3/4	3125	3/4	W-8-EPS-9400-T
8	3	3-1/4	4250	3/4	W-8-EPS-9500-T
10	2-1/2	2-3/4	3750	3/4	W-10-EPS-9400-T
10	3	3-1/4	4625	3/4	W-10-EPS-9500-T
12	2-1/2	2-3/4	4000	3/4	W-12-EPS-9400-T
12	3	3-1/4	5000	3/4	W-12-EPS-9500-T

WHEELS

HARD & SOFT RUBBER



- Inexpensive, durable, industry mainstay.
- Wheels are standard black in color. Non marking gray available, please inquire.
- Non-conductive.
- Resistant to most chemicals, oils, grease, cleaning agents, solvents and water.
- Temperature rating: -40 to 180 degrees Fahrenheit, intermittent service. (120* continuous service).
- **SOFT RUBBER:**
 - Precision molded high quality Soft Rubber molded to a Hard Rubber core.
 - Provides a smooth, cushioned ride.
 - Durometer: 70-80 Shore A.
- **HARD RUBBER:**
 - Higher load capacity than soft rubber.
 - Easy rolling, minimal effort to start up and push a load.
 - Very durable, impact resistant.
 - Durometer: 75 Shore D.

WHEEL DIAMETER TREAD WIDTH HUB LENGTH L.D.				WEIGHT CAPACITY PART # PLAIN BORE 			PART # BALL BEARING 		WEIGHT CAPACITY PART # PLAIN BORE 			PART # BALL BEARING 	
RUBBER TYPE →				HARD RUBBER					SOFT RUBBER				
2	7/8	15/16	1/4	100	W-2-HR-3000	N/A	100	W-2-SR-3000	N/A				
2	15/16	1	1/4	150	W-2-HR-4000	N/A	100	W-2-SR-4000	N/A				
2	1	1-1/8	5/16	160	W-2-HR-3800	N/A	110	W-2-SR-3800	N/A				
2-1/2	1-1/8	1-1/4	5/16	140	W-2.5-HR-4000	N/A	120	W-2.5-SR-4000	N/A				
3	1	1-3/16	5/16	130	W-3-HR-3600	N/A	110	W-3-SR-3600	N/A				
3	1-1/4	1-1/4	5/16	220	W-3-HR-3800	N/A	150	W-3-SR-3800	N/A				
3	1-1/4	1-1/2	3/8	250	W-3-HR-5200	W-3-HRB-5200	150	W-3-SR-5200	W-3-SRB-5200				
3-1/2	1-1/4	1-1/2	3/8	275	W-3.5-HR-5200	W-3.5-HRB-5200	160	W-3.5-SR-5200	W-3.5-SRB-5200				
4	1	1-3/16	5/16	175	W-4-HR-3600	N/A	130	W-4-SR-3600	N/A				
4	1-1/4	1-1/2	3/8	275	W-4-HR-5200	W-4-HRB-5200	170	W-4-SR-5200	W-4-SRB-5200				
4	1-1/2	2	3/8	300	W-4-HR-4000	N/A	225	W-4-SR-4000	N/A				
4	1-5/8	1-15/16	3/8	400	W-4-HR-5500	N/A	250	W-4-SR-5500	N/A				
5	1	1-3/16	5/16	220	W-5-HR-3600	N/A	150	W-5-SR-3600	N/A				
5	1-1/4	1-1/2	3/8	280	W-5-HR-5200	W-5-HRB-5200	200	W-5-SR-5200	W-5-SRB-5200				

WHEELS

HIGH-TEMPERATURE GLASS FILLED NYLON



- Made from a special blend of nylon & glass designed to withstand high temperatures.
- Excellent for applications demanding high capacities & high heat.
- Very durable, capable of taking shock loads.
- Resistant to water, oils, grease, gasoline, acids and most commonly used chemicals, solvents and cleaning agents.
- Durometer: 65 Shore D
- Temperature rating: 490 degrees Fahrenheit (continuous) to 550 degrees Fahrenheit (intermittently).

WHEEL DIAMETER	TREAD WIDTH	HUB LENGTH	WEIGHT CAPACITY	BEARING/BUSHING I.D.	PART # ROLLER BEARINGS, (ALL STEEL)	PART # STEEL SPANNER BUSHING	PART # BLANK (NO BEARING)	BLANK WHEEL I.D.
3	1-13/16	2	700	3/8	W-3-HTGFN-5600-C	W-3-HTGFNO-5600	W-3-HTGFN-6600-5/8	5/8
3	1-13/16	2	700	1/2	N/A	N/A	W-3-HTGFN-6600	1-3/16
3	1-13/16	2	700	5/8	W-3-HTGFN-6600-C5/8 (NO BUSHING)	N/A	W-3-HTGFN-6600	1-3/16
4	1-3/8	1-5/8	700	3/8	N/A	W-4-HTGFN-5200	W-4-HTGFN-5200-1/2	1/2
4	1-5/8	1-3/4	750	3/8	N/A	W-4-HTGFNO-5500	W-4-HTGFN-5500-1/2	1/2
4	1-5/8	1-3/4	750	13/16	N/A	N/A	W-4-HTGFN-6400-13/16	13/16
6	2	2-3/16	1200	1/2	W-6-HTGFN-6600-C	W-6-HTGFNO-6600	W-6-HTGFN-6600	1-3/16



HIGH-TEMPERATURE PHENOLIC

- Made from macerated canvas mixed with phenolic resins, pressure molded & cooked to form a highly versatile wheel.
- Excellent for applications demanding durability and capable of taking shock loads.
- Offers floor protection, is non marking and non-conductive.
- Resistant to oils, grease, gasoline and most commonly used chemicals. Wheel is resistant to water but is not recommended for wet applications.
- Durometer: 75 - 85 Shore D
- Temperature rating: -50 to +550 degrees Fahrenheit (All metal components should be used in applications over 180 degrees).

WHEEL DIAMETER	TREAD WIDTH	HUB LENGTH	WEIGHT CAPACITY	BEARING/BUSHING I.D.	PART # ROLLER BEARINGS, (ALL STEEL)	PART # STEEL SPANNER BUSHING	PART # BLANK (NO BEARING)	BLANK WHEEL I.D.
4	1-1/2	1-5/8	600	3/8	N/A	W-4-HTPHNO-5000	W-4-HTPHN-5000	1/2
4	1-1/2	1-5/8	600	1/2	N/A	N/A	W-4-HTPHN-6400-13/16	13/16
4	1-1/2	1-5/8	600	1/2	W-4-HTPHN-6400-C	N/A	N/A	1-3/16
4	2	2-3/16	1000	1/2	W-4-HTPHN-6600-C	N/A	W-4-HTPHN-6600	1-3/16
5	2	2-3/16	1000	1/2	W-5-HTPHN-6600-C	N/A	W-5-HTPHN-6600	1-3/16
6	2	2-3/16	1200	1/2	W-6-HTPHN-6600-C	N/A	W-6-HTPHN-6600	1-3/16
8	2	2-3/16	1200	1/2	W-8-HTPHN-6600-C	N/A	W-8-HTPHN-6600	1-3/16

WHEELS

PHENOLIC



- Made from macerated canvas mixed with phenolic resins, pressure molded & cooked to form a highly versatile wheel.
- Excellent for applications demanding durability and capable of taking shock loads.
- Offers floor protection, is non marking and non-conductive.
- Resistant to oils, grease, gasoline and most commonly used chemicals. Wheel is resistant to water but is not recommended for wet applications.
- Durometer: 75 - 85 Shore D
- Temperature rating: -50 to +250 degrees Fahrenheit (All metal components should be used in applications over 180 degrees).

WHEEL DIAMETER	TREAD WIDTH	HUB LENGTH	WEIGHT CAPACITY	BEARING/BUSHING I.D.	PART # STEEL, DUAL SPANNER WASHER	PART# STEEL BUSHING	BLANK WHEEL 1/2" BORE				
3	1-1/4	1-1/4	400	5/16	N/A	W-3-PHNO-3800	W-3-PHN-3800-.5				
3	1-1/4	1-3/8	400	3/8	W-3-PHN-5200-DSW	W-3-PHNO-5200	W-3-PHN-3800-.5				
3	1-1/2	1-5/8	500	3/8	N/A	W-3-PHNO-5000	W-3-PHN-5000-.5				
4	1-1/4	1-5/8	400	3/8	W-4-PHN-5200-DSW	N/A	W-4-PHN-5200-.5				
4	1-1/2	1-5/8	600	3/8	N/A	W-3-PHNO-5000	W-3-PHN-5000-.5				
5	1-1/4	1-5/8	400	3/8	W-5-PHN-5200-DSW	N/A	W-5-PHN-5200-.5				
5	1-1/2	1-5/8	750	3/8	N/A	W-5-PHNO-5000	W-5-PHN-5000-.5				
WHEEL DIAMETER	TREAD WIDTH	HUB LENGTH	WEIGHT CAPACITY	BEARING/BUSHING I.D.	PART # ROLLER BEARINGS	PART # SEALED PRECISION BALL BEARINGS	PART # TAPERED ROLLER BEARING	PART# DELRIN BEARINGS	PART# DELRIN BEARINGS .75 W/ *STEEL SPANNER	PART # BLANK (NO BEARING)	BLANK WHEEL I.D.
3-1/4	2	2-3/16	700	1/2	W-3.25-PHN-6600-C	W-3.25-PHN-6600-BB	N/A	W-3.25-PHN-6600-DB	W-3.25-PHN-6600-DBO	W-3.25-PHN-6600	
4	1-1/2	1-5/8	600	3/8	W-4-PHN-5500-C	N/A	N/A	N/A	W-4-PHN-5500-DBO	W-4-PHN-6400	1-3/16
4	1-1/2	1-5/8	600	1/2	W-4-PHN-6400-C	N/A	N/A	W-4-PHN-6400-DB	W-4-PHN-6400-DBO	W-4-PHN-6400	1-3/16
4	2	2-3/16	800	1/2	W-4-PHN-6600-C	W-4-PHN-6600-BB	N/A	W-4-PHN-6600-DB	W-4-PHN-6600-DBO	W-4-PHN-6600	1-3/16
5	1-1/2	1-5/8	750	3/8	W-5-PHN-5500-C	N/A	N/A	N/A	W-5-PHN-5500-DBO	W-5-PHN-6400	1-3/16
5	1-1/2	1-5/8	750	1/2	W-5-PHN-6400-C	N/A	N/A	W-5-PHN-6400-DB	W-5-PHN-6400-DBO	W-5-PHN-6400	1-3/16
5	2	2-3/16	1000	1/2	W-5-PHN-6600-C	W-5-PHN-6600-BB	N/A	W-5-PHN-6600-DB	W-5-PHN-6600-DBO	W-5-PHN-6600	1-3/16
6	1-1/2	1-5/8	800	3/8	W-6-PHN-5500-C	N/A	N/A	N/A	W-6-PHN-5500-DBO	W-6-PHN-6400	1-3/16
6	1-1/2	1-5/8	800	1/2	W-6-PHN-6400-C	N/A	N/A	W-6-PHN-6400-DB	W-6-PHN-6400-DBO	W-6-PHN-6400	1-3/16
6	2	2-3/16	1200	1/2	W-6-PHN-6600-C	W-6-PHN-6600-BB	N/A	W-6-PHN-6600-DB	W-6-PHN-6600-DBO	W-6-PHN-6600	1-3/16
6	2-1/2	2-3/4	1600	1/2	W-6-PHN-6825-C	N/A	N/A	W-6-PHN-6825-DB	W-6-PHN-6825-DBO	W-6-PHN-6825	1-3/16
6	2-1/2	2-3/4	1600	3/4	W-6-PHN-9400-C	N/A	W-6-PHN-9400-T	N/A	N/A	W-6-PHN-9400	1-15/16
6	2-1/2	2-3/4	1600	1	W-6-PHN-9400-C-1 (NO BUSHING)	N/A	NA	N/A	N/A	W-6-PHN-9400	1-15/16
6	2-1/2	2-3/4	1600	1-1/4	W-6-PHN-9400-C-1.25 (NO BUSHING)	N/A	NA	N/A	N/A	W-6-PHN-9400	1-15/16
6	3	3-1/4	2000	3/4	W-6-PHN-9500-C	N/A	W-6-PHN-9500-T	N/A	N/A	W-6-PHN-9500	1-15/16
6	3	3-1/4	2000	1	W-6-PHN-9500-C-1 (NO BUSHING)	N/A	NA	N/A	N/A	W-6-PHN-9500	1-15/16
6	3	3-1/4	2000	1-1/4	W-6-PHN-9500-C-1.25 (NO BUSHING)	N/A	NA	N/A	N/A	W-6-PHN-9500	1-15/16
8	2	2-3/16	1400	1/2	W-8-PHN-6600-C	W-8-PHN-6600-BB	N/A	W-8-PHN-6600-DB	W-8-PHN-6600-DBO	W-8-PHN-6600	1-3/16
8	2-1/2	2-3/4	2000	1/2	W-8-PHN-6825-C	N/A	N/A	W-8-PHN-6825-DB	W-8-PHN-6825-DBO	W-8-PHN-6825	1-3/16
8	2-1/2	2-3/4	2000	3/4	W-8-PHN-9400-C	N/A	W-8-PHN-9400-T	N/A	N/A	W-8-PHN-9400	1-15/16
8	2-1/2	2-3/4	2000	1	W-8-PHN-9400-C-1 (NO BUSHING)	N/A	NA	N/A	N/A	W-8-PHN-9400	1-15/16
8	2-1/2	2-3/4	2000	1-1/4	W-8-PHN-9400-C-1.25 (NO BUSHING)	N/A	NA	N/A	N/A	W-8-PHN-9400	1-15/16
8	3	3-1/4	2500	3/4	W-8-PHN-9500-C	N/A	W-8-PHN-9500-T	N/A	N/A	W-8-PHN-9500	1-15/16
8	3	3-1/4	2500	1	W-8-PHN-9500-C-1 (NO BUSHING)	N/A	NA	N/A	N/A	W-8-PHN-9500	1-15/16
8	3	3-1/4	2500	1-1/4	W-8-PHN-9500-C-1.25 (NO BUSHING)	N/A	NA	N/A	N/A	W-8-PHN-9500	1-15/16

* TO ORDER 3/4 DELRIN BEARING WITH DELRIN BUSHING INSTEAD OF STEEL CHANGE PART # FROM-DBO TO DBD, TO ORDER WITH STAINLESS STEEL BUSHING CHANGE TO -DBS.

WHEELS

PHENOLIC (continued)

WHEEL DIAMETER	TREAD WIDTH	HUB LENGTH	WEIGHT CAPACITY	BEARING/ BUSHING I.D.	PART # ROLLER BEARINGS	PART # TAPERED ROLLER BEARING	PART# DELRIN BEARINGS	PART# DELRIN BEARINGS .75 W/ SPANNER	PART # BLANK (NO BEARING)	BLANK WHEEL I.D.
10	2-1/2	2-3/4	2500	3/4	W-10-PHN-9400-C	W-10-PHN-9400-T	N/A	N/A	W-10-PHN-9400	1-15/16
10	2-1/2	2-3/4	2500	1	W-10-PHN-9400-C-1 (NO BUSHING)	NA	N/A	N/A	W-10-PHN-9400	1-15/16
10	2-1/2	2-3/4	2500	1-1/4	W-10-PHN-9400-C-1.25 (NO BUSHING)	NA	N/A	N/A	W-10-PHN-9400	1-15/16
10	3	3-1/4	2900	3/4	W-10-PHN-9500-C	W-10-PHN-9500-T	N/A	N/A	W-10-PHN-9500	1-15/16
10	3	3-1/4	2900	1	W-10-PHN-9500-C-1 (NO BUSHING)	NA	N/A	N/A	W-10-PHN-9500	1-15/16
10	3	3-1/4	2900	1-1/4	W-10-PHN-9500-C-1.25 (NO BUSHING)	NA	N/A	N/A	W-10-PHN-9500	1-15/16
12	2-1/2	2-3/4	3000	3/4	W-12-PHN-9400-C	W-12-PHN-9400-T	N/A	N/A	W-12-PHN-9400	1-15/16
12	2-1/2	2-3/4	3000	1	W-12-PHN-9400-C-1 (NO BUSHING)	NA	N/A	N/A	W-12-PHN-9400	1-15/16
12	2-1/2	2-3/4	3000	1-1/4	W-12-PHN-9400-C-1.25 (NO BUSHING)	NA	N/A	N/A	W-12-PHN-9400	1-15/16
12	3	3-1/4	3500	3/4	W-12-PHN-9500-C	W-12-PHN-9500-T	N/A	N/A	W-12-PHN-9500	1-15/16
12	3	3-1/4	3500	1	W-12-PHN-9500-C-1 (NO BUSHING)	NA	N/A	N/A	W-12-PHN-9500	1-15/16
12	3	3-1/4	3500	1-1/4	W-12-PHN-9500-C-1.25 (NO BUSHING)	NA	N/A	N/A	W-12-PHN-9500	1-15/16

LAMINATED PHENOLIC

LAMINATED PHENOLIC WHEELS HAVE THE SAME BASIC SPECIFICATIONS AS THE STANDARD PHENOLIC WHEELS WITH THE EXCEPTION OF WEIGHT CAPACITY. WEIGHT CAPACITIES OF LAMINATED PHENOLIC WHEELS ARE 25% GREATER THAN STANDARD PHENOLIC WHEELS.

TO ORDER LAMINATED PHENOLIC WHEELS, CHANGE THE WHEEL TYPE DESIGNATOR OF THE STANDARD PHENOLIC FROM -PHN TO -LPN (EXAMPLE: W-12-LPN-9500).

WHEELS

PNEUMATIC



- **For use in non-motorized applications only.**
- Tires made from high quality rubber with inflatable tube mounted to a durable 2 piece bolt together steel hub assembly.
- Tire available in both black or non-marking gray.
- Hub assembly comes standard with zinc plating. Also available with polished brass finish, or painted hubs: white, red or gray. Other colors and finishes available upon request, please inquire.
- **Applications:** Carts, platform trucks for industrial, commercial and institutional environments demanding a cushioned ride. Carrying sensitive materials, chemicals, electronics, ceramics, glass, sound and lighting equipment. Great for use on equipment that may need to traverse different terrains, such as: generators, compressors, pressure washers, sprayers, snow-blowers, heaters & fans, vacuums, wheel-barrows, fertilizer spreaders, wagons, lawn & garden equipment, etc.

GENERIC WHEEL DIAMETER	ACTUAL WHEEL DIAMETER	TREAD WIDTH	HUB LENGTH	WEIGHT CAPACITY	PLY RATING & TREAD TYPE	BEARING I.D.	PART # BALL BEARING (STANDARD)	PART # FLANGED PRECISION BALL	PART# FLANGED ROLLER BEARING	PART# STRAIGHT ROLLER BEARING (NO SLEEVE OR BUSHING)	PART# ROLLER BEARING (W/ SLEEVE & BUSHING)	BLANK WHEEL I.D.
TIRE COLOR & HUB TYPE						BLACK TIRE / CENTERED HUB						
6	6"	2	2-1/2	*275	4-PLY SAWTOOTH U.S. STANDARD	1/2	P-W6-CH-B-1/2	P-W6-CH-B-PB-1/2	N/A	N/A	P-W6-CH-B-RB-1/2	N/A
						5/8	N/A	N/A	N/A	P-W6-CH-B-RB-5/8		
						3/4	N/A	N/A	N/A	P-W6-CH-B-RB-3/4		
8	9" (280/250-4)	2-1/2	3	*300		1/2	P-W9-CH-B-1/2	P-W9-CH-B-PB-1/2	N/A	N/A	N/A	N/A
						5/8	P-W9-CH-B-5/8	P-W9-CH-B-PB-5/8	P-W9-CH-B-FRB-5/8	N/A	N/A	
						3/4	P-W9-CH-B-3/4	P-W9-CH-B-PB-3/4	P-W9-CH-B-FRB-3/4	N/A	N/A	
8	8.85 (280/250-4)	2-3/4	4	*300		1/2	P-W9-CHLH-B-1/2	P-W9-CHLH-B-PB-1/2	N/A	N/A	N/A	N/A
						5/8	P-W9-CHLH-B-5/8	P-W9-CHLH-B-PB-5/8	P-W9-CHLH-B-FRB-5/8	N/A	N/A	
						3/4	P-W9-CHLH-B-3/4	P-W9-CHLH-B-PB-3/4	P-W9-CHLH-B-FRB-3/4	N/A	N/A	
10	11-1/4" (410/350-4)	3-1/2	4	*350		1/2	P-W10-CH-B-1/2	P-W10-CH-B-PB-1/2	N/A	N/A	N/A	1-3/8
						5/8	P-W10-CH-B-5/8	P-W10-CH-B-PB-5/8	P-W10-CH-B-FRB-5/8	P-W10-CH-B-RB-5/8	N/A	
						3/4	P-W10-CH-B-3/4	P-W10-CH-B-PB-3/4	P-W10-CH-B-FRB-3/4	P-W10-CH-B-RB-3/4	N/A	
12	13.15" (410/350-6)	3-1/2	4-1/4	*450	1/2	P-W12-CH-B-1/2	P-W12-CH-B-PB-1/2	N/A	N/A	N/A	N/A	
					5/8	P-W12-CH-B-5/8	P-W12-CH-B-PB-5/8	P-W12-CH-B-FRB-5/8	P-W10-CH-B-RB-5/8	N/A		
					3/4	P-W12-CH-B-3/4	P-W12-CH-B-PB-3/4	P-W12-CH-B-FRB3/4	P-W10-CH-B-RB-3/4	N/A		

*Note: Wheel diameter and roll-ability may vary according to the PSI in the tire and the load it's carrying.

GENERIC WHEEL DIAMETER	ACTUAL WHEEL DIAMETER	TREAD WIDTH	HUB LENGTH	WEIGHT CAPACITY	PLY RATING & TREAD TYPE	BEARING I.D.	PART # BALL BEARING (STANDARD)	PART # FLANGED PRECISION BALL	PART# FLANGED ROLLER BEARING	PART# STRAIGHT ROLLER BEARING (NO SLEEVE OR BUSHING)	PART# ROLLER BEARING (W/ SLEEVE & BUSHING)	BLANK WHEEL I.D.
TIRE COLOR & HUB TYPE						GRAY TIRE / CENTERED HUB						
6	6"	2	2-1/2	*275	4-PLY SAWTOOTH U.S. STANDARD	1/2	P-W6-CH-G-1/2	P-W6-CH-G-PB-1/2	N/A	N/A	P-W6-CH-G-RB-1/2	N/A
						5/8	N/A	N/A	N/A	N/A	P-W6-CH-G-RB-5/8	
						3/4	N/A	N/A	N/A	N/A	P-W6-CH-G-RB-3/4	
8	9" (280/250-4)	2-1/2	3	*300		1/2	P-W9-CH-G-1/2	P-W9-CH-G-PB-1/2	N/A	N/A	N/A	N/A
						5/8	P-W9-CH-G-5/8	P-W9-CH-G-PB-5/8	P-W9-CH-G-FRB-5/8	N/A	N/A	
						3/4	P-W9-CH-G-3/4	P-W9-CH-G-PB-3/4	P-W9-CH-G-FRB-3/4	N/A	N/A	
8	8.85 (280/250-4)	2-3/4	4	*300		1/2	P-W9-CHLH-G-1/2	P-W9-CHLH-G-PB-1/2	N/A	N/A	N/A	N/A
						5/8	P-W9-CHLH-G-5/8	P-W9-CHLH-G-PB-5/8	P-W9-CHLH-G-FRB-5/8	N/A	N/A	
						3/4	P-W9-CHLH-G-3/4	P-W9-CHLH-G-PB-3/4	P-W9-CHLH-G-FRB-3/4	N/A	N/A	
10	11-1/4" (410/350-4)	3-1/2	4	*350		1/2	P-W10-CH-G-1/2	P-W10-CH-G-PB-1/2	N/A	N/A	N/A	1-3/8
						5/8	P-W10-CH-G-5/8	P-W10-CH-G-PB-5/8	P-W10-CH-G-FRB-5/8	P-W10-CH-G-RB-5/8	N/A	
						3/4	P-W10-CH-G-3/4	P-W10-CH-G-PB-3/4	P-W10-CH-G-FRB-3/4	P-W10-CH-G-RB-3/4	N/A	



WHEELS

OFFSET HUB TYPE

GENERIC WHEEL DIAMETER	ACTUAL WHEEL DIAMETER	TREAD WIDTH	HUB LENGTH	WEIGHT CAPACITY	PLY RATING & TREAD TYPE	BEARING I.D.	PART # BALL BEARING (STANDARD)	PART # FLANGED PRECISION BALL	PART# FLANGED ROLLER BEARING	BLANK WHEEL I.D.
TIRE COLOR & HUB TYPE →						BLACK TIRE / OFFSET HUB				
8	9" (280/250-4)	2-1/2	2-1/4	*300	4-PLY SAWTOOTH U.S. STANDARD	1/2	P-W9-OH-B-1/2	P-W9-OH-B-PB-1/2	N/A	1-3/8
						5/8	P-W9-OH-B-5/8	P-W9-OH-B-PB-5/8	P-W9-OH-B-FRB-5/8	
			3/4	P-W9-OH-B-3/4	P-W9-OH-B-PB-3/4	P-W9-OH-B-FRB-3/4				
8	8.85" (280/250-4)	2-3/4	*300	4-PLY SAWTOOTH U.S. STANDARD	1/2	P-W9-OH-B-1/2-10RIM	P-W9-OH-B-PB-1/2-10RIM	N/A		
					5/8	P-W9-OH-B-5/8-10RIM	P-W9-OH-B-PB-5/8-10RIM	P-W9-OH-B-FRB-5/8-10RIM		
			3/4	P-W9-OH-B-3/4-10RIM	P-W9-OH-B-PB-3/4-10RIM	P-W9-OH-B-FRB-3/4-10RIM				
10	10.2" (300-4)	3-1/4	2-1/8	*275	2-PLY DIAMOND EUROPEAN STANDARD	1/2	P-W10E-OH-B-1/2	P-W10E-OH-B-PB-1/2	N/A	
						5/8	P-W10E-OH-B-5/8	P-W10E-OH-B-PB-5/8	P-W10E-OH-B-FRB-5/8	
						3/4	P-W10E-OH-B-3/4	P-W10E-OH-B-PB-3/4	P-W10E-OH-B-FRB-3/4	
10	11-1/4" (410/350-4)	3-1/2	2-1/4	*350	4-PLY SAWTOOTH U.S. STANDARD	1/2	P-W10-OH-B-1/2	P-W10-OH-B-PB-1/2	N/A	
						5/8	P-W10-OH-B-5/8	P-W10-OH-B-PB-5/8	P-W10-OH-B-FRB-5/8	
						3/4	P-W10-OH-B-3/4	P-W10-OH-B-PB-3/4	P-W10-OH-B-FRB-3/4	
12	13.15" (410/350-6)	3-1/2	3-1/4	*450	4-PLY SAWTOOTH U.S. STANDARD	1/2	P-W12-OH-B-1/2	P-W12-OH-B-PB-1/2	N/A	
						5/8	P-W12-OH-B-5/8	P-W12-OH-B-PB-5/8	P-W12-OH-B-FRB-5/8	
						3/4	P-W12-OH-B-3/4	P-W12-OH-B-PB-3/4	P-W12-OH-B-FRB3/4	

*Note: Wheel diameter and roll-ability may vary according to the PSI in the tire and the load it's carrying.

GENERIC WHEEL DIAMETER	ACTUAL WHEEL DIAMETER	TREAD WIDTH	HUB LENGTH	WEIGHT CAPACITY	PLY RATING & TREAD TYPE	BEARING I.D.	PART # BALL BEARING (STANDARD)	PART # FLANGED PRECISION BALL	PART# FLANGED ROLLER BEARING	BLANK WHEEL I.D.
TIRE COLOR & HUB TYPE →						GRAY TIRE / OFFSET HUB				
8	9" (280/250-4)	2-1/2	2-1/4	*300	4-PLY SAWTOOTH U.S. STANDARD	1/2	P-W9-OH-G-1/2	P-W9-OH-G-PB-1/2	N/A	1-3/8
						5/8	P-W9-OH-G-5/8	P-W9-OH-G-PB-5/8	P-W9-OH-G-FRB-5/8	
			3/4	P-W9-OH-G-3/4	P-W9-OH-G-PB-3/4	P-W9-OH-G-FRB-3/4				
8	8.85" (280/250-4)	2-3/4	*300	4-PLY SAWTOOTH U.S. STANDARD	1/2	P-W9-OH-G-1/2-10RIM	P-W9-OH-G-PB-1/2-10RIM	N/A		
					5/8	P-W9-OH-G-5/8-10RIM	P-W9-OH-G-PB-5/8-10RIM	P-W9-OH-G-FRB-5/8-10RIM		
			3/4	P-W9-OH-G-3/4-10RIM	P-W9-OH-G-PB-3/4-10RIM	P-W9-OH-G-FRB-3/4-10RIM				
10	10.2" (300-4)	3-1/4	2-1/8	*275	2-PLY DIAMOND EUROPEAN STANDARD	1/2	P-W10E-OH-G-1/2	P-W10E-OH-G-PB-1/2	N/A	
						5/8	P-W10E-OH-G-5/8	P-W10E-OH-G-PB-5/8	P-W10E-OH-G-FRB-5/8	
						3/4	P-W10E-OH-G-3/4	P-W10E-OH-G-PB-3/4	P-W10E-OH-G-FRB-3/4	
10	11-1/4" (410/350-4)	3-1/2	2-1/4	*350	4-PLY SAWTOOTH U.S. STANDARD	1/2	P-W10-OH-G-1/2	P-W10-OH-G-PB-1/2	N/A	
						5/8	P-W10-OH-G-5/8	P-W10-OH-G-PB-5/8	P-W10-OH-G-FRB-5/8	
						3/4	P-W10-OH-G-3/4	P-W10-OH-G-PB-3/4	P-W10-OH-G-FRB-3/4	

*Note: Wheel diameter and roll-ability may vary according to the PSI in the tire and the load it's carrying.

WHEELS

POLYOLEFIN



- Made from high quality polyolefin.
- Economical hard durometer wheel, excellent for applications demanding durability, capable of taking extreme shock loads.
- Light weight, high capacity.
- Offers floor protection, is non marking and non-conductive.
- Resistant to water, oils, grease, gasoline and most commonly used chemicals.
- Durometer: 60-70 Shore D
- Temperature rating: -45 to +180 degrees Fahrenheit

WHEEL DIAMETER	TREAD WIDTH	HUB LENGTH	WEIGHT CAPACITY	BEARING/BUSHING I.D.	PART # BALL BEARING	PART# STEEL BUSHING	BLANK WHEEL BORE
2	13/16	15/16	100	1/4	N/A	N/A	W-2-LDP-3000
2	15/16	1	150	1/4	N/A	N/A	W-2-LDP-4000
2	1	1-1/8	160	5/16	N/A	N/A	W-2-HDP-3800
2	1-3/4	1-13/16	260	5/16	N/A	N/A	W-2-HDP-3300
2-1/2	1-1/8	1-1/4	200	5/16	N/A	N/A	W-2.5-HDP-4000
3	1	1-3/16	175	5/16	N/A	N/A	W-3-LDP-3600
3	1-4	1-1/4	250	5/16	N/A	N/A	W-3-LDP-3800
3	1-1/4	1-1/2	250	3/8	N/A	N/A	W-3-LDP-5200
3	1-1/4	1-1/2	250	1/2	N/A	N/A	W-3-HDP-4000.5
3	1-3/8	1-1/2	300	3/8	W-3-HDPB-5200	N/A	W-3-HDP-5200
3-1/2	1-1/4	1-1/2	300	3/8	N/A	N/A	W-3.5-HDP-5200
4	1	1-3/16	220	5/16	N/A	W-4-HDPO-3600	N/A
4	1-1/4	1-1/2	300	3/8	N/A	N/A	W-4-HDP-5200
4	1-1/4	1-1/2	300	1/2	N/A	N/A	W-4-HDP-5000.5
4	1-5/8	1-15/16	500	3/8	N/A	W-4-XDPO-5500	N/A
4	1-5/8	1.92	500	1/2	N/A	N/A	W-4-XDP-5500.5
5	1	1-3/16	230	5/16	N/A	W-5-HDPO-3600	N/A
5	1-1/4	1-1/2	325	3/8	N/A	W-5-HDPO-5200	W-5-HDP-5200
5	1-5/8	1-15/16	500	3/8	N/A	W-5-XDPO-5500	N/A
5	1-5/8	1.92	500	1/2	N/A	N/A	W-5-XDP-5500.5

WHEEL DIAMETER	TREAD WIDTH	HUB LENGTH	WEIGHT CAPACITY	BEARING/BUSHING I.D.	PART # ROLLER BEARINGS	PART # PRECISION SEALED BB	PART # OILITE BUSHING	PART #SEALED PRECISION BALL BEARING	PART# DELRIN BEARINGS	PART# DELRIN BEARINGS .75 W/ *STEEL SPANNER	PART # BLANK (NO BEARING)	BLANK WHEEL I.D.
3	1-13/16	2	700	3/8	W-3-XDP-5600-C	W-3-XDPP-5600	W-3-XDPO-5600	N/A	N/A	N/A	W-3-XDP-6600-5/8	5/8
3	1-13/16	2	700	1/2	N/A	N/A	N/A	N/A	W-3-XDP-6600-DB	N/A	W-3-XDP-6600	1-3/16
3	1-13/16	2	700	5/8	W-3-XDP-6600-C5/8 (NO BUSHING)	N/A	N/A	N/A	N/A	N/A	W-3-XDP-6600	1-3/16
4	1-1/2	1-5/8	500	3/8	W-4-XDP-5500-C	N/A	N/A	N/A	N/A	W-4-XDP-5500-DBO	W-4-XDP-6400	1-3/16
4	1-1/2	1-5/8	500	1/2	W-4-XDP-6400-C	N/A	N/A	N/A	W-4-XDP-6400-DB	W-4-XDP-6400-DBO	W-4-XDP-6400	1-3/16
4	2	2-3/16	700	1/2	W-4-XDP-6600-C	N/A	N/A	W-4-XDP-6600-BB	W-4-XDP-6600-DB	W-4-XDP-6600-DBO	W-4-XDP-6600	1-3/16
5	1-1/2	1-5/8	550	3/8	W-5-XDP-5500-C	N/A	N/A	N/A	N/A	W-5-XDP-5500-DBO	W-5-XDP-6400	1-3/16
5	1-1/2	1-5/8	550	1/2	W-5-XDP-6400-C	N/A	N/A	N/A	W-5-XDP-6400-DB	W-5-XDP-6400-DBO	W-5-XDP-6400	1-3/16
5	2	2-3/16	900	1/2	W-5-XDP-6600-C	N/A	N/A	W-5-XDP-6600-BB	W-5-XDP-6600-DB	W-5-XDP-6600-DBO	W-5-XDP-6600	1-3/16
6	1-1/2	1-5/8	600	3/8	W-6-XDP-5500-C	N/A	N/A	N/A	N/A	W-6-XDP-5500-DBO	W-6-XDP-6400	1-3/16
6	1-1/2	1-5/8	600	1/2	W-6-XDP-6400-C	N/A	N/A	N/A	W-6-XDP-6400-DB	W-6-XDP-6400-DBO	W-6-XDP-6400	1-3/16
6	2	2-3/16	700	1/2	N/A	N/A	N/A	N/A	N/A	N/A	W-6-HDP-6600-PB	1/2
6	2	2-3/16	1200	1/2	N/A	N/A	W-6-XDPO-6600	N/A	N/A	N/A	W-6-XDP-6600-PB	1/2
6	2	2-3/16	1200	3/4	N/A	N/A	N/A	N/A	N/A	N/A	W-6-XDP-6600-3/4	3/4
6	2	2-3/16	1300	1/2	W-6-XDP-6600-C	W-6-XDPP-6600-C	N/A	W-6-XDP-6600-BB	W-6-XDP-6600-DB	W-6-XDP-6600-DBO	W-6-XDP-6600	1-3/16
8	2	2-3/16	1400	1/2	W-8-XDP-6600-C	N/A	N/A	W-8-XDP-6600-BB	W-8-XDP-6600-DB	W-8-XDP-6600-DBO	W-8-XDP-6600	1-3/16

* TO ORDER 3/4 DELRIN BEARING WITH DELRIN BUSHING INSTEAD OF STEEL CHANGE PART # FROM-DBO TO DBD, TO ORDER WITH STAINLESS STEEL BUSHING CHANGE TO -DBS.



WHEELS

POLYURETHANE ON ALUMINUM



- Precision molded high quality polyurethane chemically bonded to a smooth, polished aluminum core, provides a very versatile, strong and attractive wheel.
- The combination of a slight crowned tread and high quality annular ball bearings provide exceptionally low effort to start up and push a load. Great for ergonomic applications.
- Great wheel for foodservice and institutional applications, meets NSF & UL sanitation standards.
- Resistant to most chemicals, oils, grease, cleaning agents, solvents and water.
- Offers floor protection, is non marking and non-conductive.
- 2, color combinations available. Blue polyurethane is standard. Red available upon request, please inquire about availability.
- Durometer: 95 Shore A.
- Temperature rating: -40 to 180 degrees Fahrenheit.

Picture shown with optional bearing covers (matches tread color, Blue), to order wheel with bearing covers put a -BC at the end of the wheel part # Example: W-5-PAL-5200-BC. Or order bearing covers per piece (2 needed per wheel) #BC-PAL

WHEEL DIAMETER	TREAD WIDTH	HUB LENGTH	WEIGHT CAPACITY	BEARING/ BUSHING I.D.	PART # ROLLER BEARINGS	PART # SEALED PRECISION BALL BEARINGS	PART # ANNULAR BALL BEARING	PART# DELRIN BEARINGS	PART# DELRIN BEARINGS .75 W/ *STEEL SPANNER	PART # BLANK (NO BEARING)	BLANK WHEEL I.D.
BLUE POLYURETHANE ON ALUMINUM											
3	1-1/4	1-5/8	380	3/8	N/A	N/A	W-3-PAL-5200	N/A	N/A	N/A	N/A
3-1/2	1-1/4	1-5/8	400	3/8	N/A	N/A	W-3.5-PAL-5200	N/A	N/A	N/A	N/A
4	1-1/4	1-5/8	420	3/8	N/A	N/A	W-4-PAL-5200	N/A	N/A	N/A	N/A
4	2	2-3/16	800	1/2	W-4-PAL-6600-C	W-4-PAL-6600-BB	N/A	W-4-PAL-6600-DB	W-4-PAL-6600-DBO	W-4-PAL-6600	1-3/16
5	1-1/4	1-5/8	440	3/8	N/A	N/A	W-5-PAL-5200	N/A	N/A	N/A	N/A
5	2	2-3/16	1200	1/2	W-5-PAL-6600-C	W-5-PAL-6600-BB	N/A	W-5-PAL-6600-DB	W-5-PAL-6600-DBO	W-5-PAL-6600	1-3/16
6	1-1/4	1-5/8	450	3/8	N/A	N/A	W-6-PAL-5200	N/A	N/A	N/A	N/A
6	2	2-3/16	1250	1/2	W-6-PAL-6600-C	W-6-PAL-6600-BB	N/A	W-6-PAL-6600-DB	W-6-PAL-6600-DBO	W-6-PAL-6600	1-3/16
8	2	2-3/16	1500	1/2	W-8-PAL-6600-C	W-8-PAL-6600-BB	N/A	W-8-PAL-6600-DB	W-8-PAL-6600-DBO	W-8-PAL-6600	1-3/16

* TO ORDER 3/4 DELRIN BEARING WITH DELRIN BUSHING INSTEAD OF STEEL CHANGE PART # FROM-DBO TO DBD, TO ORDER WITH STAINLESS STEEL BUSHING CHANGE TO -DBS.

WHEELS

POLYURETHANE ON CAST IRON



- High quality polyurethane chemically bonded to a painted cast iron core.
- Polyurethane is 5/16" to a 1/2" thick, depending on the size of the wheel.
- Offers floor protection, is non marking and delivers somewhat of a cushioned and quieter ride than a standard hard tread or steel wheel.
- Resistant to most chemicals, oils, acids, grease and water.
- Standard color is green on silver, however other colors are available, please inquire.
- Durometer: 95 Shore A
- Temperature rating: -40 to 180 degrees Fahrenheit.

WHEEL DIAMETER	TREAD WIDTH	HUB LENGTH	WEIGHT CAPACITY	BEARING/ BUSHING I.D.	PART # ROLLER BEARINGS	PART # SEALED PRECISION BALL BEARINGS	PART # TAPERED ROLLER BEARING	PART# DELRIN BEARINGS	PART# DELRIN BEARINGS .75 W/ *STEEL SPANNER	PART # BLANK (NO BEARING)	BLANK WHEEL I.D.
4	1-1/2	1-5/8	500	3/8	W-4-PCI-5500-C	N/A	N/A	N/A	W-4-PCI-5500-DBO	W-4-PCI-6400	1-3/16
4	1-1/2	1-5/8	600	1/2	W-4-PCI-6400-C	N/A	N/A	W-4-PCI-6400-DB	W-4-PCI-6400-DBO	W-4-PCI-6400	1-3/16
4	2	2-3/16	800	1/2	W-4-PCI-6600-C	W-4-PCI-6600-BB	N/A	W-4-PCI-6600-DB	W-4-PCI-6600-DBO	W-4-PCI-6600	1-3/16
5	1-1/2	1-5/8	500	3/8	W-5-PCI-5500-C	N/A	N/A	N/A	W-5-PCI-5500-DBO	W-5-PCI-6400	1-3/16
5	1-1/2	1-5/8	750	1/2	W-5-PCI-6400-C	N/A	N/A	W-5-PCI-6400-DB	W-5-PCI-6400-DBO	W-5-PCI-6400	1-3/16
5	2	2-3/16	1200	1/2	W-5-PCI-6600-C	W-5-PCI-6600-BB	N/A	W-5-PCI-6600-DB	W-5-PCI-6600-DBO	W-5-PCI-6600	1-3/16
6	1-1/2	1-5/8	500	3/8	W-6-PCI-5500-C	N/A	N/A	N/A	W-6-PCI-5500-DBO	W-6-PCI-6400	1-3/16
6	1-1/2	1-5/8	750	1/2	W-6-PCI-6400-C	N/A	N/A	W-6-PCI-6400-DB	W-6-PCI-6400-DBO	W-6-PCI-6400	1-3/16
6	2	2-3/16	1250	1/2	W-6-PCI-6600-C	W-6-PCI-6600-BB	N/A	W-6-PCI-6600-DB	W-6-PCI-6600-DBO	W-6-PCI-6600	1-3/16
6	2-1/2	2-3/4	1500	1/2	W-6-PCI-6825-C	N/A	N/A	W-6-PCI-6825-DB	W-6-PCI-6825-DBO	W-6-PCI-6825	1-3/16
6	2-1/2	2-3/4	1600	3/4	W-6-PCI-9400-C	N/A	W-6-PCI-9400-T	N/A	N/A	W-6-PCI-9400	1-15/16
6	2-1/2	2-3/4	1600	1	W-6-PCI-9400-C-1 (NO BUSHING)	N/A	NA	N/A	N/A	W-6-PCI-9400	1-15/16
6	2-1/2	2-3/4	1600	1-1/4	W-6-PCI-9400-C-1.25 (NO BUSHING)	N/A	NA	N/A	N/A	W-6-PCI-9400	1-15/16
6	3	3-1/4	2000	3/4	W-6-PCI-9500-C	N/A	W-6-PCI-9500-T	N/A	N/A	W-6-PCI-9500	1-15/16
6	3	3-1/4	2000	1	W-6-PCI-9500-C-1 (NO BUSHING)	N/A	NA	N/A	N/A	W-6-PCI-9500	1-15/16
6	3	3-1/4	2000	1-1/4	W-6-PCI-9500-C-1.25 (NO BUSHING)	N/A	NA	N/A	N/A	W-6-PCI-9500	1-15/16
8	2	2-3/16	1500	1/2	W-8-PCI-6600-C	W-8-PCI-6600-BB	N/A	W-8-PCI-6600-DB	W-8-PCI-6600-DBO	W-8-PCI-6600	1-3/16
8	2-1/2	2-3/4	1500	1/2	W-8-PCI-6825-C	N/A	N/A	W-8-PCI-6825-DB	W-8-PCI-6825-DBO	W-8-PCI-6825	1-3/16
8	2-1/2	2-3/4	2000	3/4	W-8-PCI-9400-C	N/A	W-8-PCI-9400-T	N/A	N/A	W-8-PCI-9400	1-15/16
8	2-1/2	2-3/4	2000	1	W-8-PCI-9400-C-1 (NO BUSHING)	N/A	NA	N/A	N/A	W-8-PCI-9400	1-15/16
8	2-1/2	2-3/4	2000	1-1/4	W-8-PCI-9400-C-1.25 (NO BUSHING)	N/A	NA	N/A	N/A	W-8-PCI-9400	1-15/16
8	3	3-1/4	2500	3/4	W-8-PCI-9500-C	N/A	W-8-PCI-9500-T	N/A	N/A	W-8-PCI-9500	1-15/16
8	3	3-1/4	2500	1	W-8-PCI-9500-C-1 (NO BUSHING)	N/A	NA	N/A	N/A	W-8-PCI-9500	1-15/16
8	3	3-1/4	2500	1-1/4	W-8-PCI-9500-C-1.25 (NO BUSHING)	N/A	NA	N/A	N/A	W-8-PCI-9500	1-15/16
10	2-1/2	2-3/4	2100	3/4	W-10-PCI-9400-C	N/A	W-10-PCI-9400-T	N/A	N/A	W-10-PCI-9400	1-15/16
10	2-1/2	2-3/4	2100	1	W-10-PCI-9400-C-1 (NO BUSHING)	N/A	NA	N/A	N/A	W-10-PCI-9400	1-15/16
10	2-1/2	2-3/4	2100	1-1/4	W-10-PCI-9400-C-1.25 (NO BUSHING)	N/A	NA	N/A	N/A	W-10-PCI-9400	1-15/16
10	3	3-1/4	3000	3/4	W-10-PCI-9500-C	N/A	W-10-PCI-9500-T	N/A	N/A	W-10-PCI-9500	1-15/16
10	3	3-1/4	3000	1	W-10-PCI-9500-C-1 (NO BUSHING)	N/A	NA	N/A	N/A	W-10-PCI-9500	1-15/16
10	3	3-1/4	3000	1-1/4	W-10-PCI-9500-C-1.25 (NO BUSHING)	N/A	NA	N/A	N/A	W-10-PCI-9500	1-15/16
12	2-1/2	2-3/4	2200	3/4	W-12-PCI-9400-C	N/A	W-12-PCI-9400-T	N/A	N/A	W-12-PCI-9400	1-15/16
12	2-1/2	2-3/4	2200	1	W-12-PCI-9400-C-1 (NO BUSHING)	N/A	NA	N/A	N/A	W-12-PCI-9400	1-15/16
12	2-1/2	2-3/4	2200	1-1/4	W-12-PCI-9400-C-1.25 (NO BUSHING)	N/A	NA	N/A	N/A	W-12-PCI-9400	1-15/16
12	3	3-1/4	3500	3/4	W-12-PCI-9500-C	N/A	W-12-PCI-9500-T	N/A	N/A	W-12-PCI-9500	1-15/16
12	3	3-1/4	3500	1	W-12-PCI-9500-C-1 (NO BUSHING)	N/A	NA	N/A	N/A	W-12-PCI-9500	1-15/16
12	3	3-1/4	3500	1-1/4	W-12-PCI-9500-C-1.25 (NO BUSHING)	N/A	NA	N/A	N/A	W-12-PCI-9500	1-15/16

* TO ORDER 3/4 DELRIN BEARING WITH DELRIN BUSHING INSTEAD OF STEEL CHANGE PART # FROM-DBO TO DBD, TO ORDER WITH STAINLESS STEEL BUSHING CHANGE TO -DBS.



WHEELS

POLYURETHANE ON POLYOLEFIN



- Precision molded high quality polyurethane mechanically locked to a durable polyolefin core, provides a very versatile, strong and attractive wheel.
- Resistant to most chemicals, oils, grease, cleaning agents, solvents and water.
- Offers floor protection, is non marking and non-conductive.
- 4, color combinations available.
- **Plain bore** option provides an economical alternative to ball bearings and has the same advantages as delrin bearings with added durability and are less expensive. Great for use in sanitary & wet applications. Provides sufficient roll-ability for most jobs.
- * Several small sizes come standard with a spanner bushing providing stability to the yoke.
- **Ball bearing** option provides greater roll-ability and less effort to push a load. Bearing covers available: add -BCG to the end of the part number (example: W-5-PPBG-5200-BCG)
- Durometer: 95 Shore A.
- Temperature rating: -40 to 180 degrees Fahrenheit.

COLOR →					GRAY ON BEIGE (Standard)		BLUE ON GRAY		RED ON GRAY		BLACK ON BEIGE	
2	15/16	1	110	1/4	W-2-PPPG-4000	N/A	W-2-PPPL-4000	N/A	W-2-PPPR-4000	N/A	W-2-PPPK-4000	N/A
2-1/2	1-1/8	1-13/32	160	5/16	W-2.5-PPOG-3800*	N/A	W-2.5-PPOL-3800*	N/A	W-2.5-PPOR-3800*	N/A	W-2.5-PPOK-3800*	N/A
3	1	1-3/16	175	5/16	W-3-PPPG-3600	N/A	W-3-PPPL-3600	N/A	W-3-PPPR-3600	N/A	W-3-PPPK-3600	N/A
3	1-1/4	1-1/4	250	5/16	W-3-PPOG-3800*	N/A	W-3-PPOL-3800*	N/A	W-3-PPOR-3800*	N/A	W-3-PPOK-3800*	N/A
3	1-1/4	1-1/2	250	3/8	W-3-PPPG-5200	W-3-PPBG-5200	W-3-PPPL-5200	W-3-PPBL-5200	W-3-PPPR-5200	W-3-PPBR-5200	W-3-PPPK-5200	W-3-PPBK-5200
3-1/2	1-1/4	1-1/2	250	3/8	W-3.5-PPPG-5200	W-3.5-PPBG-5200	W-3.5-PPPL-5200	W-3.5-PPBL-5200	W-3.5-PPPR-5200	W-3.5-PPBR-5200	W-3.5-PPPK-5200	W-3.5-PPBK-5200
4	1	1-3/16	220	5/16	W-4-PPPG-3600	N/A	W-4-PPPL-3600	N/A	W-4-PPPR-3600	N/A	W-4-PPPK-3600	N/A
4	1-1/4	1-1/2	275	3/8	W-4-PPPG-5200	W-4-PPBG-5200	W-4-PPPL-5200	W-4-PPBL-5200	W-4-PPPR-5200	W-4-PPBR-5200	W-4-PPPK-5200	W-4-PPBK-5200
5	1	1-3/16	220	5/16	W-5-PPPG-3600	N/A	W-5-PPPL-3600	N/A	W-5-PPPR-3600	N/A	W-5-PPPK-3600	N/A
5	1-1/4	1-1/2	300	3/8	W-5-PPPG-5200	W-5-PPBG-5200	W-5-PPPL-5200	W-5-PPBL-5200	W-5-PPPR-5200	W-5-PPBR-5200	W-5-PPPK-5200	W-5-PPBK-5200
6	1-1/4	1-1/2	300	3/8	N/A	W-6-PPBG-5200	N/A	W-6-PPBL-5200	N/A	W-6-PPBR-5200	N/A	W-6-PPBK-5200

Check availability on non-standard color wheels, some have become standard stock items.



Bearing covers: Available to aid in keeping small particles from getting into the bearings. One size fits all.
Order 2 per wheel. [Part #BCG-5200](#), bearing covers are easy to install, just snaps onto the bearing.



Thread guards: Originally designed for the textile industry preventing threads from wrapping around the bearing and axle and have found uses in many other applications including the institutional and foodservice industries. Our polished metal thread guards provide a strong, attractive look and are effective in keeping all types of unwanted material out of the bearings and have even met the sanitary standards of NSF (please inquire for NSF details).
Order 2 per wheel.
[See page 55 to find the correct size of thread guards.](#)

WHEELS

POLYURETHANE ON POLYOLEFIN



- Precision molded high quality polyurethane mechanically locked to a durable polyolefin core, provides a very versatile, strong and attractive wheel.
- Resistant to most chemicals, oils, grease, cleaning agents, solvents and water.
- Offers floor protection, is non marking and non-conductive.
- 4, color combinations available.
- Durometer: 95 Shore A.
- Temperature rating: -40 to 180 degrees Fahrenheit.

BLUE ON BLACK

WHEEL DIAMETER	TREAD WIDTH	HUB LENGTH	WEIGHT CAPACITY	BEARING/ BUSHING I.D.	PART # ROLLER BEARINGS	PART # SEALED PRECISION BALL BEARINGS	PART# DELRIN BEARINGS	PART# DELRIN BEARINGS .75 W/ *STEEL SPANNER	PART # BLANK (NO BEARING)	BLANK WHEEL I.D.
4	1-1/2	1-5/8	500	3/8	W-4-XLB-5500-C	N/A	N/A	W-4-XLB-5500-DBO	W-4-XLB-6400	1-3/16
4	1-1/2	1-5/8	500	1/2	W-4-XLB-6400-C	N/A	W-4-XLB-6400-DB	W-4-XLB-6400-DBO	W-4-XLB-6400	1-3/16
4	2	2-3/16	800	1/2	W-4-XLB-6600-C	W-4-XLB-6600-BB	W-4-XLB-6600-DB	W-4-XLB-6600-DBO	W-4-XLB-6600	1-3/16
5	1-1/2	1-5/8	550	3/8	W-5-XLB-5500-C	N/A	N/A	W-5-XLB-5500-DBO	W-5-XLB-6400	1-3/16
5	1-1/2	1-5/8	550	1/2	W-5-XLB-6400-C	N/A	W-5-XLB-6400-DB	W-5-XLB-6400-DBO	W-5-XLB-6400	1-3/16
5	2	2-3/16	900	1/2	W-5-XLB-6600-C	W-5-XLB-6600-BB	W-5-XLB-6600-DB	W-5-XLB-6600-DBO	W-5-XLB-6600	1-3/16
6	1-1/2	1-5/8	600	3/8	W-6-XLB-5500-C	N/A	N/A	W-6-XLB-5500-DBO	W-6-XLB-6400	1-3/16
6	1-1/2	1-5/8	600	1/2	W-6-XLB-6400-C	N/A	W-6-XLB-6400-DB	W-6-XLB-6400-DBO	W-6-XLB-6400	1-3/16
6	2	2-3/16	1000	1/2	W-6-XLB-6600-C	W-6-XLB-6600-BB	W-6-XLB-6600-DB	W-6-XLB-6600-DBO	W-6-XLB-6600	1-3/16
8	2	2-3/16	1100	1/2	W-8-XLB-6600-C	W-8-XLB-6600-BB	W-8-XLB-6600-DB	W-8-XLB-6600-DBO	W-8-XLB-6600	1-3/16
GRAY ON BEIGE										
5	2	2-3/16	900	1/2	W-5-XLG-6600-C	W-5-XLG-6600-BB	W-5-XLG-6600-DB	W-5-XLG-6600-DBO	W-5-XLG-6600	1-3/16
8	2	2-3/16	1100	1/2	W-8-XLG-6600-C	W-8-XLG-6600-BB	W-8-XLG-6600-DB	W-8-XLG-6600-DBO	W-8-XLG-6600	1-3/16

* TO ORDER 3/4 DELRIN BEARING WITH DELRIN BUSHING INSTEAD OF STEEL CHANGE PART # FROM-DBO TO DBD, TO ORDER WITH STAINLESS STEEL BUSHING CHANGE TO -DBS.

WHEELS

SOLID POLYURETHANE



- Molded from high performance liquid cast polyurethane.
- Extraordinarily easy to push, minimal effort required to start-up and push loads
- Capable of withstanding high shock loads and abusive conditions.
- Resist's abrasions, breaking, chipping & cracking.
- Resistant to most chemicals, oils, grease, cleaning agents, solvents and water.
- Durometer: 55-65 Shore D.
- Temperature rating: -40 to 180 degrees Fahrenheit, intermittent service. (120 continuous service).

WHEEL DIAMETER	TREAD WIDTH	HUB LENGTH	WEIGHT CAPACITY	BEARING/ BUSHING I.D.	PART # ROLLER BEARINGS	PART # SEALED PRECISION BALL BEARINGS	PART# DELRIN BEARINGS	PART# DELRIN BEARINGS .75 W/ *STEEL SPANNER	PART # BLANK (NO BEARING)	BLANK WHEEL I.D.
4	2	2-3/16	800	1/2	W-4-SPU-6600-C	W-4-SPU-6600-BB	W-4-SPU-6600-DB	W-4-SPU-6600-DBO	W-4-SPU-6600	1-3/16
5	2	2-3/16	1000	1/2	W-5-SPU-6600-C	W-5-SPU-6600-BB	W-5-SPU-6600-DB	W-5-SPU-6600-DBO	W-5-SPU-6600	1-3/16
6	2	2-3/16	1200	1/2	W-6-SPU-6600-C	W-6-SPU-6600-BB	W-6-SPU-6600-DB	W-6-SPU-6600-DBO	W-6-SPU-6600	1-3/16
8	2	2-3/16	1300	1/2	W-8-SPU-6600-C	W-8-SPU-6600-BB	W-8-SPU-6600-DB	W-8-SPU-6600-DBO	W-8-SPU-6600	1-3/16

* TO ORDER 3/4 DELRIN BEARING WITH DELRIN BUSHING INSTEAD OF STEEL CHANGE PART # FROM-DBO TO DBD, TO ORDER WITH STAINLESS STEEL BUSHING CHANGE TO -DBS.



SOLID POLYURETHANE W/STEEL INSERT & SEALED PRECISION BALL BEARINGS

- Molded from high performance liquid cast polyurethane, chemically and mechanically bonded to a steel core.
- Extraordinarily easy to push, minimal effort required to start-up and push loads
- Capable of withstanding high shock loads and abusive conditions.
- Resist's abrasions, breaking, chipping & cracking.
- Steel core along with sealed precision ball bearings (6203) provide superior strength and move-ability and well as the capability of being used in a continuous tow-line application without the wear and failures associated with other types of wheels and bearings.
- Resistant to most chemicals, oils, grease, cleaning agents, solvents and water.
- Durometer: 55-65 Shore D.
- Temperature rating: -40 to 180 degrees Fahrenheit, intermittent service. (120 continuous service).

WHEEL DIAMETER	TREAD WIDTH	HUB LENGTH	WEIGHT CAPACITY	BEARING/ BUSHING I.D.	PART # PRECISION 6203 SEALED BB	PART # BLANK (NO BEARING)	BLANK WHEEL I.D.
4	2	2-3/16	900	1/2	W-4-SPUP-6600-C	W-4-SPUP-6600	1.572
5	2	2-3/16	1200	1/2	W-5-SPUP-6600-C	W-5-SPUP-6600	1.572
6	2	2-3/16	1400	1/2	W-6-SPUP-6600-C	W-6-SPUP-6600	1.572
8	2	2-3/16	1500	1/2	W-8-SPUP-6600-C	W-8-SPUP-6600	1.572

WHEELS

RUBBER ON ALUMINUM



Picture shown with optional bearing covers (matches tread color, gray), to order wheel with bearing covers put a -BC at the end of the wheel part #
 Example: W-5-PAL-5200-BC
 Or order bearing covers per piece (2 needed per wheel) #BC-RAL

- Precision molded high quality gray rubber chemically bonded to a smooth, polished aluminum core, provides a very versatile, strong and attractive wheel.
- The combination of an upgraded annular bearing (on 1-1/4 tread wheels) and soft rubber tread provides an exceptionally smooth, cushioned ride, with minimal effort required to start up and push a load. Having a cushioned ride provides the advantage of being able to roll over small debris and small obstacles on the floor like electrical cords, door thresholds, tiled floors, etc.
- Great wheel for foodservice and institutional applications, meets NSF & UL sanitation standards.
- Offers floor protection, is non marking and non-conductive.
- Resistant to most chemicals, oils, grease, cleaning agents, solvents and water.
- Standard color is gray rubber, black rubber is also available, change part number to RALB please call for availability (This most likely will be a factory order item).
- Durometer: 65 to 75 Shore A.
- Temperature rating: -40 to 180 degrees Fahrenheit, intermittent service. (120 continuous service).

WHEEL DIAMETER	TREAD WIDTH	HUB LENGTH	WEIGHT CAPACITY	I.D.	PART # ANNULAR BALL BEARING	PART # ROLLER BEARINGS	PART # SEALED PRECISION BALL BEARINGS	PART # BLANK (NO BEARING)	BLANK WHEEL I.D.
3	1-1/4	1-1/2	250	3/8	W-3-RAL-5200	N/A	N/A	N/A	N/A
3-1/2	1-1/4	1-1/2	250	3/8	W-3.5-RAL-5200	N/A	N/A	N/A	N/A
4	1-1/4	1-1/2	250	3/8	W-4-RAL-5200	N/A	N/A	N/A	N/A
4	2	2-3/16	350	1/2	N/A	W-4-RAL-6600-C	W-4-RAL-6600-BB	W-4-RAL-6600	1-3/16
5	1-1/4	1-1/2	250	3/8	W-5-RAL-5200	N/A	N/A	N/A	N/A
5	2	2-3/16	500	1/2	N/A	W-5-RAL-6600-C	W-5-RAL-6600-BB	W-5-RAL-6600	1-3/16
6	1-1/4	1-1/2	250	3/8	W-6-RAL-5200	N/A	N/A	N/A	N/A
6	2	2-3/16	500	1/2	N/A	W-6-RAL-6600-C	W-6-RAL-6600-BB	W-6-RAL-6600	1-3/16
8	2	2-3/16	600	1/2	N/A	W-8-RAL-6600-C	W-8-RAL-6600-BB	W-8-RAL-6600	1-3/16

BALLOON CUSHION RUBBER ON ALUMINUM



- Extra thick, precision molded high grade gray rubber chemically bonded to a aluminum core, provides a very versatile, strong and attractive wheel.
- Fully crowned tread provides easier movement when turning and less resistance pushing or pulling a load.
- Excellent wheel for applications demanding a cushioned ride.
- Offers superior floor protection, is non marking and non-conductive.
- Standard color is gray rubber (GRND), black rubber is also available (RND). If black tread is desired, please call for availability (This most likely will be a factory order item).
- Durometer: 65+-5 Shore A.

WHEEL DIAMETER	TREAD WIDTH	HUB LENGTH	WEIGHT CAPACITY	I.D.	PART # ANNULAR BALL BEARING	PART # BLANK (NO BEARING)	BLANK WHEEL I.D.
6	2	2-3/16	350	1/2	W-6-GRND-66BB-1/2	W-6-GRND-6600	1-3/8
				5/8	W-6-GRND-66BB-5/8		
				3/4	W-6-GRND-66BB-3/4		
8	2	2-3/16	450	1/2	W-8-GRND-66BB-1/2	W-8-GRND-6600	1-3/8
				5/8	W-8-GRND-66BB-5/8		
				3/4	W-8-GRND-66BB-3/4		

WHEELS

RUBBER ON CAST IRON



- High quality cushion rubber, chemically bonded to a painted cast iron core.
- Offers exceptional floor protection.
- Provides excellent shock loading, dampens vibration and provides a quite ride.
- Soft tread wheel helps the equipment its attached to, roll over debris and uneven floor conditions.
- Standard color is black on black.
- Durometer: 60 - 80 Shore A
- Temperature rating: -40 to 180 degrees Fahrenheit.

WHEEL DIAMETER	TREAD WIDTH	HUB LENGTH	WEIGHT CAPACITY	BEARING/ BUSHING I.D.	PART # ROLLER BEARINGS	PART # SEALED PRECISION BALL BEARINGS	PART # TAPERED ROLLER BEARING	PART # DELRIN BEARINGS	PART # DELRIN BEARINGS .75 W/ *STEEL SPANNER	PART # BLANK (NO BEARING)	BLANK WHEEL I.D.
4	1-1/2	1-5/8	300	3/8	W-4-RCI-5500-C	N/A	N/A	N/A	W-4-RCI-5500-DBO	W-4-RCI-6400	1-3/16
4	1-1/2	1-5/8	300	1/2	W-4-RCI-6400-C	N/A	N/A	W-4-RCI-6400-DB	W-4-RCI-6400-DBO	W-4-RCI-6400	1-3/16
4	2	2-3/16	350	1/2	W-4-RCI-6600-C	W-4-RCI-6600-BB	N/A	W-4-RCI-6600-DB	W-4-RCI-6600-DBO	W-4-RCI-6600	1-3/16
5	1-1/2	1-5/8	345	3/8	W-5-RCI-5500-C	N/A	N/A	N/A	W-5-RCI-5500-DBO	W-5-RCI-6400	1-3/16
5	1-1/2	1-5/8	345	1/2	W-5-RCI-6400-C	N/A	N/A	W-5-RCI-6400-DB	W-5-RCI-6400-DBO	W-5-RCI-6400	1-3/16
5	2	2-3/16	450	1/2	W-5-RCI-6600-C	W-5-RCI-6600-BB	N/A	W-5-RCI-6600-DB	W-5-RCI-6600-DBO	W-5-RCI-6600	1-3/16
6	1-1/2	1-5/8	375	3/8	W-6-RCI-5500-C	N/A	N/A	N/A	W-6-RCI-5500-DBO	W-6-RCI-6400	1-3/16
6	1-1/2	1-5/8	375	1/2	W-6-RCI-6400-C	N/A	N/A	W-6-RCI-6400-DB	W-6-RCI-6400-DBO	W-6-RCI-6400	1-3/16
6	2	2-3/16	500	1/2	W-6-RCI-6600-C	W-6-RCI-6600-BB	N/A	W-6-RCI-6600-DB	W-6-RCI-6600-DBO	W-6-RCI-6600	1-3/16
6	2-1/2	2-3/4	750	1/2	W-6-RCI-6825-C	N/A	N/A	W-6-RCI-6825-DB	W-6-RCI-6825-DBO	W-6-RCI-6825	1-3/16
6	2-1/2	2-3/4	750	3/4	W-6-RCI-9400-C	N/A	W-6-RCI-9400-T	N/A	N/A	W-6-RCI-9400	1-15/16
6	2-1/2	2-3/4	750	1	W-6-RCI-9400-C-1 (NO BUSHING)	N/A	NA	N/A	N/A	W-6-RCI-9400	1-15/16
6	2-1/2	2-3/4	750	1-1/4	W-6-RCI-9400-C-1.25 (NO BUSHING)	N/A	NA	N/A	N/A	W-6-RCI-9400	1-15/16
6	3	3-1/4	750	3/4	W-6-RCI-9500-C	N/A	W-6-RCI-9500-T	N/A	N/A	W-6-RCI-9500	1-15/16
6	3	3-1/4	750	1	W-6-RCI-9500-C-1 (NO BUSHING)	N/A	NA	N/A	N/A	W-6-RCI-9500	1-15/16
6	3	3-1/4	750	1-1/4	W-6-RCI-9500-C-1.25 (NO BUSHING)	N/A	NA	N/A	N/A	W-6-RCI-9500	1-15/16
8	2	2-3/16	600	1/2	W-8-RCI-6600-C	W-8-RCI-6600-BB	N/A	W-8-RCI-6600-DB	W-8-RCI-6600-DBO	W-8-RCI-6600	1-3/16
8	2-1/2	2-3/4	900	1/2	W-8-RCI-6825-C	N/A	N/A	W-8-RCI-6825-DB	W-8-RCI-6825-DBO	W-8-RCI-6825	1-3/16
8	2-1/2	2-3/4	900	3/4	W-8-RCI-9400-C	N/A	W-8-RCI-9400-T	N/A	N/A	W-8-RCI-9400	1-15/16
8	2-1/2	2-3/4	900	1	W-8-RCI-9400-C-1 (NO BUSHING)	N/A	NA	N/A	N/A	W-8-RCI-9400	1-15/16
8	2-1/2	2-3/4	900	1-1/4	W-8-RCI-9400-C-1.25 (NO BUSHING)	N/A	NA	N/A	N/A	W-8-RCI-9400	1-15/16
8	3	3-1/4	900	3/4	W-8-RCI-9500-C	N/A	W-8-RCI-9500-T	N/A	N/A	W-8-RCI-9500	1-15/16
8	3	3-1/4	900	1	W-8-RCI-9500-C-1 (NO BUSHING)	N/A	NA	N/A	N/A	W-8-RCI-9500	1-15/16
8	3	3-1/4	900	1-1/4	W-8-RCI-9500-C-1.25 (NO BUSHING)	N/A	NA	N/A	N/A	W-8-RCI-9500	1-15/16
10	2	2-3/16	1000	1/2	W-10-RCI-6600-C	W-10-RCI-6600-BB	N/A	W-10-RCI-6600-DB	W-10-RCI-6600-DBO	W-10-RCI-6600	1-3/16
10	2-1/2	2-3/4	1000	3/4	W-10-RCI-9400-C	N/A	W-10-RCI-9400-T	N/A	N/A	W-10-RCI-9400	1-15/16
10	2-1/2	2-3/4	1000	1	W-10-RCI-9400-C-1 (NO BUSHING)	N/A	NA	N/A	N/A	W-10-RCI-9400	1-15/16
10	2-1/2	2-3/4	1000	1-1/4	W-10-RCI-9400-C-1.25 (NO BUSHING)	N/A	NA	N/A	N/A	W-10-RCI-9400	1-15/16
10	3	3-1/4	1000	3/4	W-10-RCI-9500-C	N/A	W-10-RCI-9500-T	N/A	N/A	W-10-RCI-9500	1-15/16
10	3	3-1/4	1000	1	W-10-RCI-9500-C-1 (NO BUSHING)	N/A	NA	N/A	N/A	W-10-RCI-9500	1-15/16
10	3	3-1/4	1000	1-1/4	W-10-RCI-9500-C-1.25 (NO BUSHING)	N/A	NA	N/A	N/A	W-10-RCI-9500	1-15/16
12	2-1/2	2-3/4	1200	3/4	W-12-RCI-9400-C	N/A	W-12-RCI-9400-T	N/A	N/A	W-12-RCI-9400	1-15/16
12	2-1/2	2-3/4	1200	1	W-12-RCI-9400-C-1 (NO BUSHING)	N/A	NA	N/A	N/A	W-12-RCI-9400	1-15/16
12	2-1/2	2-3/4	1200	1-1/4	W-12-RCI-9400-C-1.25 (NO BUSHING)	N/A	NA	N/A	N/A	W-12-RCI-9400	1-15/16
12	3	3-1/4	1200	3/4	W-12-RCI-9500-C	N/A	W-12-RCI-9500-T	N/A	N/A	W-12-RCI-9500	1-15/16
12	3	3-1/4	1200	1	W-12-RCI-9500-C-1 (NO BUSHING)	N/A	NA	N/A	N/A	W-12-RCI-9500	1-15/16
12	3	3-1/4	1200	1-1/4	W-12-RCI-9500-C-1.25 (NO BUSHING)	N/A	NA	N/A	N/A	W-12-RCI-9500	1-15/16

* TO ORDER 3/4 DELRIN BEARING WITH DELRIN BUSHING INSTEAD OF STEEL CHANGE PART # FROM-DBO TO DBD, TO ORDER WITH STAINLESS STEEL BUSHING CHANGE TO -DBS.

WHEELS

STEEL (CAST IRON)



- Made from premium cast iron or otherwise known as semi-steel.
- Cost effective, long lasting wheel for medium to high weight applications.
- Resistant to abrasions or applications that may tear up soft tread wheels.
- Minimal effort required to start-up and push loads.
- Great for applications requiring extreme temperatures.
- Temperature rating: -40 to +800 degrees Fahrenheit (All metal components should be used in applications over 180 degrees).
- Durometer: 130-150 Brielle

WHEEL DIAMETER	TREAD WIDTH	HUB LENGTH	WEIGHT CAPACITY	BEARING/ BUSHING I.D.	BLANK WHEEL 1/2" BORE
2	15/16	1-1/32	125	1/4	W-2-STL-4000
2	1	1-1/8	160	5/16	W-2-STL-3800
2-1/2	1-1/8	1-3/8	200	5/16	W-2.5-STL-4000
3	1-1/4	1-1/2	300	3/8	W-3-STL-5200
4	1-1/4	1-9/16	400	3/8	W-4-STL-5200

WHEEL DIAMETER	TREAD WIDTH	HUB LENGTH	WEIGHT CAPACITY	BEARING/ BUSHING I.D.	PART # ROLLER BEARINGS	PART # SEALED PRECISION BALL BEARINGS	PART # TAPERED ROLLER BEARING	PART# DELRIN BEARINGS	PART# DELRIN BEARINGS, 75 W/ *STEEL SPANNER	PART # BLANK (NO BEARING)	BLANK WHEEL I.D.
4	1-1/2	1-5/8	650	3/8	W-4-STL-5500-C	N/A	N/A	N/A	W-4-STL-5500-DBO	W-4-STL-6400	1-3/16
4	1-1/2	1-5/8	650	1/2	W-4-STL-6400-C	N/A	N/A	W-4-STL-6400-DB	W-4-STL-6400-DBO	W-4-STL-6400	1-3/16
4	2	2-3/16	1000	1/2	W-4-STL-6600-C	W-4-STL-6600-BB	N/A	W-4-STL-6600-DB	W-4-STL-6600-DBO	W-4-STL-6600	1-3/16
5	1-1/2	1-5/8	700	3/8	W-5-STL-5500-C	N/A	N/A	N/A	W-5-STL-5500-DBO	W-5-STL-6400	1-3/16
5	1-1/2	1-5/8	700	1/2	W-5-STL-6400-C	N/A	N/A	W-5-STL-6400-DB	W-5-STL-6400-DBO	W-5-STL-6400	1-3/16
5	2	2-3/16	1000	1/2	W-5-STL-6600-C	W-5-STL-6600-BB	N/A	W-5-STL-6600-DB	W-5-STL-6600-DBO	W-5-STL-6600	1-3/16
6	1-1/2	1-5/8	750	3/8	W-6-STL-5500-C	N/A	N/A	N/A	W-6-STL-5500-DBO	W-6-STL-6400	1-3/16
6	1-1/2	1-5/8	750	1/2	W-6-STL-6400-C	N/A	N/A	W-6-STL-6400-DB	W-6-STL-6400-DBO	W-6-STL-6400	1-3/16
6	2	2-3/16	1400	1/2	W-6-STL-6600-C	W-6-STL-6600-BB	N/A	W-6-STL-6600-DB	W-6-STL-6600-DBO	W-6-STL-6600	1-3/16
6	2-1/2	2-3/4	2500	1/2	W-6-STL-6825-C	N/A	N/A	W-6-STL-6825-DB	W-6-STL-6825-DBO	W-6-STL-6825	1-3/16
6	2-1/2	2-3/4	2500	3/4	W-6-STL-9400-C	N/A	W-6-STL-9400-T	N/A	N/A	W-6-STL-9400	1-15/16
6	2-1/2	2-3/4	2500	1	W-6-STL-9400-C-1 (NO BUSHING)	N/A	NA	N/A	N/A	W-6-STL-9400	1-15/16
6	2-1/2	2-3/4	2500	1-1/4	W-6-STL-9400-C-1.25 (NO BUSHING)	N/A	NA	N/A	N/A	W-6-STL-9400	1-15/16
6	3	3-1/4	2500	3/4	W-6-STL-9500-C	N/A	W-6-STL-9500-T	N/A	N/A	W-6-STL-9500	1-15/16
6	3	3-1/4	2500	1	W-6-STL-9500-C-1 (NO BUSHING)	N/A	NA	N/A	N/A	W-6-STL-9500	1-15/16
6	3	3-1/4	2500	1-1/4	W-6-STL-9500-C-1.25 (NO BUSHING)	N/A	NA	N/A	N/A	W-6-STL-9500	1-15/16
8	2	2-3/16	1400	1/2	W-8-STL-6600-C	W-8-STL-6600-BB	N/A	W-8-STL-6600-DB	W-8-STL-6600-DBO	W-8-STL-6600	1-3/16
8	2-1/2	2-3/4	2500	1/2	W-8-STL-6825-C	N/A	N/A	W-8-STL-6825-DB	W-8-STL-6825-DBO	W-8-STL-6825	1-3/16
8	2-1/2	2-3/4	2500	3/4	W-8-STL-9400-C	N/A	W-8-STL-9400-T	N/A	N/A	W-8-STL-9400	1-15/16
8	2-1/2	2-3/4	2500	1	W-8-STL-9400-C-1 (NO BUSHING)	N/A	NA	N/A	N/A	W-8-STL-9400	1-15/16
8	2-1/2	2-3/4	2500	1-1/4	W-8-STL-9400-C-1.25 (NO BUSHING)	N/A	NA	N/A	N/A	W-8-STL-9400	1-15/16
8	3	3-1/4	2500	3/4	W-8-STL-9500-C	N/A	W-8-STL-9500-T	N/A	N/A	W-8-STL-9500	1-15/16
8	3	3-1/4	2500	1	W-8-STL-9500-C-1 (NO BUSHING)	N/A	NA	N/A	N/A	W-8-STL-9500	1-15/16
8	3	3-1/4	2500	1-1/4	W-8-STL-9500-C-1.25 (NO BUSHING)	N/A	NA	N/A	N/A	W-8-STL-9500	1-15/16

* TO ORDER 3/4 DELRIN BEARING WITH DELRIN BUSHING INSTEAD OF STEEL CHANGE PART # FROM-DBO TO DBD, TO ORDER WITH STAINLESS STEEL BUSHING CHANGE TO -DBS.



WHEELS

STEEL (CAST IRON) continued...

WHEEL DIAMETER	TREAD WIDTH	HUB LENGTH	WEIGHT CAPACITY	BEARING/ BUSHING I.D.	PART # ROLLER BEARINGS	PART # SEALED PRECISION BALL BEARINGS	PART # TAPERED ROLLER BEARING	PART# DELRIN BEARINGS	PART# DELRIN BEARINGS .75 W/ *STEEL SPANNER	PART # BLANK (NO BEARING)	BLANK WHEEL I.D.
10	2-1/2	2-3/4	2700	3/4	W-10-STL-9400-C	N/A	W-10-STL-9400-T	N/A	N/A	W-10-STL-9400	1-15/16
10	2-1/2	2-3/4	2700	1	W-10-STL-9400-C-1 (NO BUSHING)	N/A	NA	N/A	N/A	W-10-STL-9400	1-15/16
10	2-1/2	2-3/4	2700	1-1/4	W-10-STL-9400-C-1.25 (NO BUSHING)	N/A	NA	N/A	N/A	W-10-STL-9400	1-15/16
10	3	3-1/4	2700	3/4	W-10-STL-9500-C	N/A	W-10-STL-9500-T	N/A	N/A	W-10-STL-9500	1-15/16
10	3	3-1/4	2700	1	W-10-STL-9500-C-1 (NO BUSHING)	N/A	NA	N/A	N/A	W-10-STL-9500	1-15/16
10	3	3-1/4	2700	1-1/4	W-10-STL-9500-C-1.25 (NO BUSHING)	N/A	NA	N/A	N/A	W-10-STL-9500	1-15/16
12	2-1/2	2-3/4	2500	3/4	W-12-STL-9400-C	N/A	W-12-STL-9400-T	N/A	N/A	W-12-STL-9400	1-15/16
12	2-1/2	2-3/4	2500	1	W-12-STL-9400-C-1 (NO BUSHING)	N/A	NA	N/A	N/A	W-12-STL-9400	1-15/16
12	2-1/2	2-3/4	2500	1-1/4	W-12-STL-9400-C-1.25 (NO BUSHING)	N/A	NA	N/A	N/A	W-12-STL-9400	1-15/16
12	3	3-1/4	2500	3/4	W-12-STL-9500-C	N/A	W-12-STL-9500-T	N/A	N/A	W-12-STL-9500	1-15/16
12	3	3-1/4	2500	1	W-12-STL-9500-C-1 (NO BUSHING)	N/A	NA	N/A	N/A	W-12-STL-9500	1-15/16
12	3	3-1/4	2500	1-1/4	W-12-STL-9500-C-1.25 (NO BUSHING)	N/A	NA	N/A	N/A	W-12-STL-9500	1-15/16

WHEELS

THERMO PLASTIC RUBBER



- Precision molded high quality Thermal Plastic Rubber mechanically locked to a durable polyolefin core.
- Provides a smooth, cushioned ride.
- Offers floor protection, is non marking and non-conductive.
- Resistant to most chemicals, oils, grease, cleaning agents, solvents and water.
- **Plain bore** option provides an economical alternative to ball bearings and has the same advantages as delrin bearings with added durability and are less expensive. Great for use in sanitary & wet applications. Provides sufficient roll-ability for most jobs.
* Several small sizes come standard with a spanner bushing providing stability to the yoke.
- **Ball bearing** option provides greater roll-ability and less effort to push a load. Bearing covers available: add -BCG to the end of the part number (example: W-5-TRB-5200-BCG)
- Durometer: 55-65 Shore A.
- Temperature rating: -40 to 180 degrees Fahrenheit, intermittent service. (120 continuous service).

WHEEL DIAMETER	TREAD WIDTH	HUB LENGTH	WEIGHT CAPACITY	I.D.	PART # PLAIN BORE	PART # BALL BEARING	PART # PLAIN BORE	PART # BALL BEARING
COLOR →					GRAY ON BEIGE (Standard)		BLACK ON BEIGE	
2	7/8	31/32	100	1/4	W-2-TRP-4000	N/A	W-2-TRPK-4000	N/A
2	1	1-5/32	120	5/16	W-2-TRP-3800	N/A	W-2-TRPK-3800	N/A
2-1/2	7/8	31/32	105	1/4	W-2.5-TRP-3000	N/A	W-2.5-TRPK-3000	N/A
2-1/2	1-1/8	1-13/32	150	5/16	W-2.5-TRO-3800*	N/A	W-2.5-TROK-3800*	N/A
3	7/8	31/32	110	1/4	W-3-TRP-3000	N/A	W-3-TRPK-3000	N/A
3	1	1-3/16	175	5/16	W-3-TRP-3600	N/A	W-3-TRPK-3600	N/A
3	1-1/4	1-1/4	210	5/16	W-3-TRO-3800*	N/A	W-3-TROK-3800*	N/A
3	1-1/4	1-1/2	210	3/8	W-3-TRP-5200	W-3-TRB-5200	W-3-TRPK-5200	W-3-TRBK-5200
3-1/2	1-1/4	1-1/2	250	3/8	W-3.5-TRP-5200	W-3.5-TRB-5200	W-3.5-TRPK-5200	W-3.5-TRBK-5200
4	1	1-3/16	220	5/16	W-4-TRP-3600	N/A	W-4-TRPK-3600	N/A
4	1-1/4	1-1/2	250	3/8	W-4-TRP-5200	W-4-TRB-5200	W-4-TRPK-5200	W-4-TRBK-5200
5	1	1-3/16	220	5/16	W-5-TRP-3600	N/A	W-5-TRPK-3600	N/A
5	1-1/4	1-1/2	250	3/8	W-5-TRP-5200	W-5-TRB-5200	W-5-TRPK-5200	W-5-TRBK-5200
6	1-1/4	1-1/2	300	3/8	N/A	W-6-TRB-5200	N/A	W-6-TRBK-5200

Check availability on non-standard color wheels, some have become standard stock items.



Bearing covers: Available to aid in keeping small particles from getting into the bearings. One size fits all.
Order 2 per wheel. Part #BCG-5200, bearing covers are easy to install, just snaps onto the bearing.



Thread guards: Originally designed for the textile industry preventing threads from wrapping around the bearing and axle and have found uses in many other applications including the institutional and foodservice industries. Our polished metal thread guards provide a strong, attractive look and are effective in keeping all types of unwanted material out of the bearings and have even met the sanitary standards of NSF (please inquire for NSF details).
Order 2 per wheel.
See page 55 to find the correct size of thread guards.

WHEELS

THERMO PLASTIC RUBBER



- Precision molded high quality Thermal Plastic Rubber mechanically locked to a durable polyolefin core.
- Provides a smooth, cushioned ride.
- Offers floor protection, is non marking and non-conductive.
- Resistant to most chemicals, oils, grease, cleaning agents, solvents and water.
- Durometer: 55-65 Shore A.
- Temperature rating: -40 to 180 degrees Fahrenheit, intermittent service. (120 continuous service).

GRAY ON BEIGE

WHEEL DIAMETER	TREAD WIDTH	HUB LENGTH	WEIGHT CAPACITY	BEARING/ BUSHING I.D.	PART # ROLLER BEARINGS	PART # CAGED ROLLER BEARINGS	PART# DELRIN BEARINGS	PART# DELRIN BEARINGS .75 W/ *STEEL SPANNER	PART # BLANK (NO BEARING)	BLANK WHEEL I.D.
4	2	2-3/16	300	1/2	W-4-TPR-6600-C	W-4-TPR-6600-BB	W-4-TPR-6600-DB	W-4-TPR-6600-DBO	W-4-TPR-6600	1-3/16
5	2	2-3/16	350	1/2	W-5-TPR-6600-C	W-5-TPR-6600-BB	W-5-TPR-6600-DB	W-5-TPR-6600-DBO	W-5-TPR-6600	1-3/16
6	1-1/2	1-5/8	400	3/8	W-6-TPR-5500-C	N/A	N/A	W-6-TPR-5500-DBO	W-6-TPR-6400	1-3/16
6	1-1/2	1-5/8	400	1/2	W-6-TPR-6400-C	N/A	W-6-TPR-6400-DB	W-6-TPR-6400-DBO	W-6-TPR-6400	1-3/16
6	2	2-3/16	410	1/2	W-6-TPR-6600-C	W-6-TPR-6600-BB	W-6-TPR-6600-DB	W-6-TPR-6600-DBO	W-6-TPR-6600	1-3/16
8	2	2-3/16	500	1/2	W-8-TPR-6600-C	W-8-TPR-6600-BB	W-8-TPR-6600-DB	W-8-TPR-6600-DBO	W-8-TPR-6600	1-3/16
BLACK ON BEIGE										
8	2	2-3/16	500	1/2	W-8-TPRK-6600-C	W-8-TPRK-6600-BB	W-8-TPRK-6600-DB	W-8-TPRK-6600-DBO	W-8-TPRK-6600	1-3/16

* TO ORDER 3/4 DELRIN BEARING WITH DELRIN BUSHING INSTEAD OF STEEL CHANGE PART # FROM-DBO TO DBD, TO ORDER WITH STAINLESS STEEL BUSHING CHANGE TO -DBS.



ROUND TREAD THERMO PLASTIC RUBBER

- Precision molded high quality Thermal Plastic Rubber mechanically locked to a durable polyolefin core.
- Fully crowned wheel provides extra cushioning and swivel mobility for a smooth ride.
- This wheels ability to roll over small debris or other items like power cords & door thresholds makes it a great, versatile wheel with countless specialty applications.
- Offers floor protection, is non marking and non-conductive.
- Resistant to most chemicals, oils, grease, cleaning agents, solvents and water.
- Durometer: 55-65 Shore A.
- Temperature rating: -40 to 180 degrees Fahrenheit, intermittent service. (120 continuous service).

WHEEL DIAMETER	TREAD WIDTH	HUB LENGTH	WEIGHT CAPACITY	BEARING/ BUSHING I.D.	PART # ROLLER BEARINGS	PART # CAGED ROLLER BEARINGS	PART # GRAPHITE SLEEVE W/ STEEL SPANNER BUSHING	PART# DELRIN BEARINGS	PART# DELRIN BEARINGS .75 W/ *STEEL SPANNER	PART # BLANK (NO BEARING)	BLANK WHEEL I.D.
4	2	2-3/16	300	1/2	W-4-RTP-6600-C	W-4-RTP-6600-BB	N/A	W-4-RTP-6600-DB	W-4-RTP-6600-DBO	W-4-RTP-6600	1-3/16
5	1-1/4	1-1/2	250	3/8	N/A	N/A	W-5-RTPO-5200	N/A	N/A	N/A	N/A
5	2	2-3/16	350	1/2	W-5-RTP-6600-C	W-5-RTP-6600-BB	N/A	W-5-RTP-6600-DB	W-5-RTP-6600-DBO	W-5-RTP-6600	1-3/16
6	2	2-3/16	410	1/2	W-6-RTP-6600-C	W-6-RTP-6600-BB	N/A	W-6-RTP-6600-DB	W-6-RTP-6600-DBO	W-6-RTP-6600	1-3/16
8	2	2-3/16	500	1/2	W-8-RTP-6600-C	W-8-RTP-6600-BB	N/A	W-8-RTP-6600-DB	W-8-RTP-6600-DBO	W-8-RTP-6600	1-3/16

WHEELS

V GROOVE



- Made from premium cast iron or otherwise known as semi-steel.
- Made for use on either angle iron track, a flat surface, or both.
- Wheel is machined in the center of the tread with a relief groove at the base of the “V” directing the load to each side of the groove
- Resist’s breaking, chipping & cracking.
- Minimal effort required to start-up and push loads.
- Great for applications requiring extreme temperatures.
- Temperature rating: -40 to +800 degrees Fahrenheit (All metal components should be used in applications over 180 degrees).
- Durometer: 130-150 Brinell

WHEEL DIAMETER	TREAD WIDTH	HUB LENGTH	WEIGHT CAPACITY	BEARING/BUSHING I.D.	PART # ROLLER BEARINGS	PART # SEALED PRECISION BALL BEARINGS	PART # TAPERED ROLLER BEARING	PART# DELRIN BEARINGS	PART# DELRIN BEARINGS .75 W/ *STEEL SPANNER	PART # BLANK (NO BEARING)	BLANK WHEEL I.D.
4	1-1/2	1-1/2	600	1/2	W-4-VG-6400-C	N/A	N/A	W-4-VG-6600-DB	W-4-VG-6600-DBO	W-4-VG-6400	1-3/16
4	2	2-3/16	1000	1/2	W-4-VG-6600-C	W-4-VG-6600-BB	N/A	W-4-VG-6600-DB	W-4-VG-6600-DBO	W-4-VG-6600	1-3/16
5	2	2-3/16	1400	1/2	W-5-VG-6600-C	W-5-VG-6600-BB	N/A	W-5-VG-6600-DB	W-5-VG-6600-DBO	W-5-VG-6600	1-3/16
6	2	2-3/16	1400	1/2	W-6-VG-6600-C	W-6-VG-6600-BB	N/A	W-6-VG-6600-DB	W-6-VG-6600-DBO	W-6-VG-6600	1-3/16
6	2-1/2	2-3/4	2000	3/4	W-6-VG-9400-C	N/A	W-6-VG-9400-T	N/A	N/A	W-6-VG-9400	1-15/16
6	2-1/2	2-3/4	2000	1	W-6-VG-9400-C-1 (NO BUSHING)	N/A	NA	N/A	N/A	W-6-VG-9400	1-15/16
6	2-1/2	2-3/4	2000	1-1/4	W-6-VG-9400-C-1.25 (NO BUSHING)	N/A	NA	N/A	N/A	W-6-VG-9400	1-15/16
6	3	3-1/4	2500	3/4	W-6-VG-9500-C	N/A	W-6-VG-9500-T	N/A	N/A	W-6-VG-9500	1-15/16
6	3	3-1/4	2500	1	W-6-VG-9500-C-1 (NO BUSHING)	N/A	NA	N/A	N/A	W-6-VG-9500	1-15/16
6	3	3-1/4	2500	1-1/4	W-6-VG-9500-C-1.25 (NO BUSHING)	N/A	NA	N/A	N/A	W-6-VG-9500	1-15/16
8	2	2-3/16	1400	1/2	W-8-VG-6600-C	W-8-VG-6600-BB	N/A	W-8-VG-6600-DB	W-8-VG-6600-DBO	W-8-VG-6600	1-3/16
8	2-1/2	2-3/4	2500	3/4	W-8-VG-9400-C	N/A	W-8-VG-9400-T	N/A	N/A	W-8-VG-9400	1-15/16
8	2-1/2	2-3/4	2500	1	W-8-VG-9400-C-1 (NO BUSHING)	N/A	NA	N/A	N/A	W-8-VG-9400	1-15/16
8	2-1/2	2-3/4	2500	1-1/4	W-8-VG-9400-C-1.25 (NO BUSHING)	N/A	NA	N/A	N/A	W-8-VG-9400	1-15/16
8	3	3-1/4	2800	3/4	W-8-VG-9500-C	N/A	W-8-VG-9500-T	N/A	N/A	W-8-VG-9500	1-15/16
8	3	3-1/4	2800	1	W-8-VG-9500-C-1 (NO BUSHING)	N/A	NA	N/A	N/A	W-8-VG-9500	1-15/16
8	3	3-1/4	2800	1-1/4	W-8-VG-9500-C-1.25 (NO BUSHING)	N/A	NA	N/A	N/A	W-8-VG-9500	1-15/16

* TO ORDER 3/4 DELRIN BEARING WITH DELRIN BUSHING INSTEAD OF STEEL CHANGE PART # FROM-DBO TO DBD, TO ORDER WITH STAINLESS STEEL BUSHING CHANGE TO -DBS.

MATERIAL HANDLING EQUIPMENT



"U-BOAT" UTILITY CART

Applications:

The primary application of this style of cart has been for use as stocking carts in grocery & department stores. High end handles enable product to be stacked securely. The narrow 16" width of the cart makes it easy to maneuver through busy aisles. Many other applications can be found for these carts.

Features:

- All heavy gauge steel construction made to withstand the toughest abuse while moving heavy loads.
- Diamond deck surface, helps to keep loads from slipping off cart.
- Durable powder coat finish gives attractive look while offering exceptional protection to the steel construction.
- Unique, quick change plates provide the advantage of shipping cart and casters in separate boxes. The customer can easily install the casters by clipping them into the quick change plate. This feature also makes replacing casters a breeze.

Specifications:

	ECONOMY CART	DELUXE CART
PART NUMBER	#UB-1660-DD-ECONOMY	#UB-1660-DD-DELUXE
LENGTH:	60" Inches.	60" Inches.
FRAME WIDTH:	16" Inches.	16" Inches.
HEIGHT:	62	62
WEIGHT CAPACITY:	2200	2200
SHIPPING WEIGHT:	105	105
2 MIDDLE CASTERS	8" x 2" Blue non-marking Polyurethane on black Polyolefin, rigid casters with roller bearings and zerck axles. (#6680R-01-XLB)	8" x 2" Gray non-marking Thermal Plastic Rubber on Polyolefin, rigid casters with roller bearings and zerck axles. (#6680R-01-TPR)
4 OUTSIDE CORNER CASTERS	4" x 1-1/4" Non-marking black Polyolefin, swivel casters. (#5040-01-HDP)	4" x 1-1/4" Gray non-marking Thermal Plastic Rubber on Polyolefin, swivel casters. (#5040-01-TRP)

Brakes are available on the 8" rigid casters. Please inquire.

MATERIAL HANDLING EQUIPMENT

APPLIANCE HANDTRUCK

Features

- All heavy gauge steel construction made to withstand the toughest abuse while moving heavy loads.
- Double ratchet straps with spring-loaded automatic strap recoil.
- Straps made out of durable 3-ply nylon interwoven fabric, 2 piece straps with clamps, secured by heavy steel rivets.
- All parts that would face the equipment being moved are protected with felt/carpeting or thermal plastic rubber bumpers.
- Equipped with rugged step crawlers to aid in moving the loaded hand truck up stairs, and in & out of vehicles.

Specifications

- Height: 60"
- Frame width: 16"
- Foot plate: 5" x 24"
- Weight capacity: 750 lbs.
- Weight: 47 lbs.
- 6" x 2" polyurethane on polyolefin wheels with roller bearings.

Part #: HT-60X16-DR



MATERIAL HANDLING EQUIPMENT

FOLD-OUT HANDTRUCK



Features

- All heavy gauge aluminum construction made to be light weight and withstand the toughest abuse while moving heavy loads.
- Provides the features of both a traditional style 2 wheel hand-truck and a 4 wheel platform truck in one.
- Quickly converts from hand-truck to platform-truck by pressing the release, mainframe slides up and down into the desired configuration.

Specifications:

REGULAR-SIZE	SUPER-SIZE	
Hand-truck height: 52" Fold-out truck height: 40" Frame width: 12" Fold-out bed length: 38-1/2" Foot plate dimensions: 7-1/2" x 18" Hand-truck capacity: 500 lbs. Fold-out truck capacity: 1000 lbs.	Hand-truck height: 61" Fold-out truck height: 45" Frame width: 12" Fold-out bed length: 51" Foot plate dimensions: 7-1/2 x 18 Hand-truck capacity: 500 lbs. Fold-out truck capacity: 1000 lbs.	
	REGULAR PART NUMBER	SUPERSIZE PART NUMBER
STANDARD HAND-TRUCK (Comes with 8" rubber on aluminum wheels & 4" poly-u on poly-o swivel casters)		
Weight with standard wheels	37 lbs.	43 lbs.
PART NUMBER (standard type):	HT-FDSR	HT-FDSS
PNEUMATIC HAND-TRUCK (Comes with 10" pneumatic wheels & 5" round tread TPR swivel casters)		
Weight with pneumatic wheels	44 lbs.	50 lbs.
PART NUMBER (pneumatic type):	HT-FDPR	HT-FDPS



MATERIAL HANDLING EQUIPMENT





STACKABLE, "STAR DOLLY"

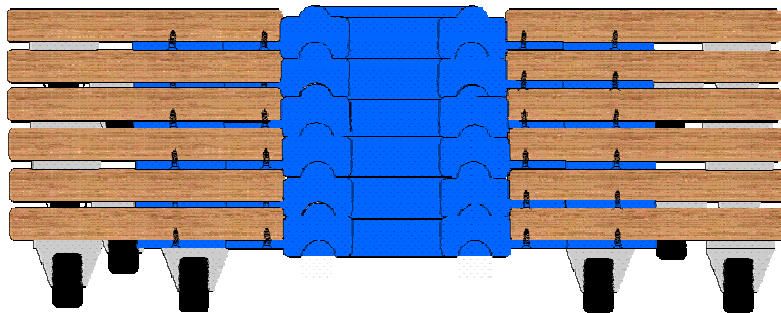

- Sturdy 1" plywood construction for durability.
- Padded end caps for non-slip, scuff-free contact.
- 6" Hole in the middle of dolly for easy carrying and stacking.
- Unique, interlocking space-saver design enables dollies to be stacked up high in one column.
- Dollies may be stacked on the casters down for moving the whole column. Or, casters up for transporting in a truck.
- Our unique 5 caster star design allows a significant advantage in weight capacity over traditional dollies, up to 1200 lb. capacity per dolly.
- Five 4" casters provide excellent mobility & stability.
- Dolly weighs approximately 24-26 lbs with 5" casters.



DOLLY CASTER OPTIONS, SPECS & PART NUMBERS

DOLLY CASTER OPTIONS, SPECS & PART NUMBERS			
CASTER TYPE		WHEEL PICTURE	Dolly part #
 <ul style="list-style-type: none"> • Caster yoke is stamped and drawn from heavily embossed steel. • Case hardened double ball swivel raceways provide extra capacity, durability and increased mobility. 			
PREMIUM CASTER DOLLEY, WHEEL SPECS			
<ul style="list-style-type: none"> • Wheels are precision molded high quality polyurethane chemically bonded to a smooth, polished aluminum core. Provides a very versatile, strong and attractive wheel. • The combination of a slight crowned tread and high quality annular ball bearings provide exceptionally low effort to start up and push a load. Great for ergonomic applications. • Offers floor protection, is non marking and non-conductive. • Wheel has a bearing cover to prevent debris from clogging up the bearings, blue tread and bearing cover match with the dollies reinforced center piece and carpet. 			STAR-28"-PAL-BC STAR-35"-PAL-BC
CUSHION CASTER DOLLEY, WHEEL SPECS			
<ul style="list-style-type: none"> • Precision molded high quality, gray non-marking rubber, chemically bonded to a smooth, polished aluminum core, provides a very versatile, strong and attractive wheel. • The combination of an upgraded annular bearing and the soft rubber tread provides an exceptionally smooth, cushioned ride, with minimal effort required to start up and push a load. Having a cushioned ride provides the advantage of being able to roll over small debris and small obstacles on the floor like electrical cords, door thresholds, tiled floors, etc. • Wheel has a bearing cover to prevent debris from clogging up the bearings, the bearing cover matches the wheel tread color. 			STAR-28"-RAL-BC STAR-35"-RAL-BC
ECONOMY CASTER DOLLEY, WHEEL SPECS			
<ul style="list-style-type: none"> • These wheels are made from high quality polyolefin. • Economical hard durometer wheel, excellent for applications demanding durability. Capable of taking extreme shock loads. • Light weight, high capacity. • Offers floor protection, is non marking and non-conductive. 			STAR-28"-HDP STAR-35"-HDP

CUSTOM DESIGNED WHEELS



If you require a special wheel, and can't find what you need from our standard product line, we have the capability to custom design one that will meet your exact specifications.

Please call your local distributor for more information.
(Minimum order requirements apply.)



Acorn Industrial Products Co
 520 Hertzog Boulevard
 King of Prussia, PA 19406
 Phone 800-523-5474
 Fax 800-782-6780
 E-Mail acorn@acornindprod.com

